



DCD APPROVED A+ CATEGORY COMPANY

KEEP OFF FIRE,
WITH A TEAM ON FIRE!
MAF - A SAFER WORLD IN THE MAKING!



800 FIRE-8003473

PRE QUALIFICATION

PRE-QUALIFICATION DOCUMENT

CONTENTS

- HIGHLIGHTS
- INTRODUCTION
- CHAIRMAN’S MESSAGE
- CMD’S MESSAGE
- CEO’S MESSAGE
- BUSINESS SEGMENTS
- APPLICATIONS
- MISSION AND VISION
- CORE VALUES
- ORGANIZATION CHART
- LICENSES & CERTIFICATES
- KEY PERSONS
- QUALITY POLICY
- 24X7 ASSISTANT
- HSE POLICY
- CSR POLICY
- PRODUCTS
- VEHICLES DETAILS
- CSR ACTIVITIES
- OUR TEAM
- LIST OF MAJOR CLIENTS



HIGHLIGHTS

Year of Establishment	: 2012
Chairman	: Mr. Majid Obaid Juma Bin Majid Al Falasi
Name of the Bankers	: 1) RAK BANK 2) Emirates NBD 3) ADCB
Office Location	: Al Qusais, Industrial Area 5, Dubai, UAE.
Office Area	: 4,500 SQ FT
No of Employees	: 60
No of Vehicles	: 12
24x7 Support	: 800 FIRE [800 3473]
Contact No	: +971 4 2397 910, Fax: +971 4 2398 710
Email	: info@mafsafety.ae
Website	: www.mafsafety.ae



INTRODUCTION



DUNES CAPITAL INITIATIVE

MAF is the flagship brand of Dunes Capital Initiative, one of the leading business conglomerates in the United Arab Emirates, that comes with a wide spectrum of business segments. The important brands under the DCI umbrella include:

- MAF Fire Safety & Security L.L.C
- MAF Gas L.L.C
- MAF Trading L.L.C
- MAF MEP LLC



MAF FIRE SAFETY & SECURITY L.L.C

MAF Fire Safety & Security LLC is a leading name in the fire & safety industry, based out of the UAE. Right from manufacture and supply of fire fighting equipment's, to installing the most advanced fire combating utilities in buildings, MAF takes care of all your requirements, when it comes to high-profile safety from the hazards of fire.

Founded in the year 2012, in the global city of Dubai, MAF offers turnkey solutions to an elite clientele that cuts across various business and social segments. MAF is a UAE based business conglomerate that ventures into a diversified range of service segments.

THE PROJECT

We're passionate about what we do. All those small, yet crucial tasks involved in the designing of a complete fire fighting system excites us. Thus, we would be more than happy to assist you right from the conception stage of a project. This gives you an added advantage of having the benefit to avail our expertise right from stage 1, so that your dream project will have a fire detection and fire fighting setup of the highest standards.



ANNUAL MAINTENANCE CONTRACT.

Having problems with your existing fire fighting and fire alarm systems? Worry not!

We can be of help by serving you with an Annual Maintenance Contract (AMC). You can avail our services any day and any time for an AMC, with the assurance of quick response and responsibility. As a part of the AMC, we take over your existing system and closely monitor all crucial elements including fire detection and alarm systems, fire fighting systems, emergency lighting & central battery systems and deluge systems among others.

As a part of the AMC, we also help our clients with the necessary documentation, clearances and periodic certifications that are required as part of compliance to local rules and regulations.

FITOUTS

As a service dedicated to all kinds of business segments, we offer specialized services for smaller spaces such as fit-outs, that operate as a part of a larger structure. This is crucial because during an emergency, it is easier to spring into action and keep the space danger-free.

RECTIFICATION

Building up a tamper-proof fire safety system is an expert task. Even the minutest of error would augment itself into a grave situation, rapidly. So, remain safe by correcting any flaw that occurs in your existing system with our exclusive rectification services.





MAF GAS L.L.C

With a vision to venture into diverse business portfolios, MAF has also entered into the LPG, NG and SNG Systems installation and support service sector. We have proved our expertise in the development, production and distribution of cutting-edge technologies for the safe and efficient use of LPG, NG and SNG systems.

Right from consulting and design, to testing and maintaining, MAF Gas is all equipped with a dedicated team of engineers and professionals, ready to take on projects of all scopes and scales. Whether a new project or an existing one, we have customized design solutions to cater to the requirements of all kinds of structures including residential, commercial, industrials, hotels, malls, villas etc.

The Activities

- Projects
- Annual Maintenance Contract
- Fit out

Some of our products and services include:

Central Gas System

- Residential
- Commercial
- Industrial

Installation and Annual Maintenance

Specialized pipeline & fittings installation

- LPG/NG/SNG Pipeline
- Industrial Gases Pipeline
- Fuel tank pipeline
- Medical Gas pipeline

LPG Vaporizer

Control Valves and Regulators

Gas Flow Meters

Gas Solenoid Valves

Pressure Vessel Fittings

Gas Detection Systems

Gas Tank Level Monitoring System

Industrial Gas Detection Systems





MAF TRADING L.L.C

All the products in the MAF portfolio have received international acclaim and recognition. They are most trusted by all our customers too. Sometimes even our best of customers come seeking our products to replace some of their existing brands for reasons. As a brand, committed to provide extended service to all our customers, we make sure that they get what they need.

We deal with fire and safety products of many other brands, presenting our customers with a wide array of value-for-money options.



MAF MEP LLC

MAF MEP LLC is a professionally managed organization. It has built its reputation by introducing innovative state of art technologies in concept, development, design, planning, scheduling and execution of projects. We are undertaking Construction RCC Projects, Industrial Steel Fabrication & Erection Projects, Electro-mechanical projects and Interior Fit-Out Projects. Company has assigned qualified and well-experienced expertise to ensure the successful results of our projects. Company intention is to build up business relation with our clients based on reliable execution of projects within the specified schedule.

MAF MEP LLC carries out general construction concept, design, planning, implementation and execution of diversified projects on a turnkey basis for electrical and mechanical installation, operation and maintenance of commercial and industrial buildings, warehouses etc.

MAF MEP LLC prides itself in its reputation as a business built around people offering excellence and an assured quality product which is second to none, with a commitment for the highest technical and managerial abilities and prioritized safety, incorporating state-of-the-art technology in modern and traditional construction.



MESSAGE FROM OUR CHAIRMAN

It is with great pleasure that I introduce MAF FIRE SAFETY & SECURITY L.L.C. In the present world, the word “safety” has high relevance; hence we have proudly renewed our motto to “a safer world.”

Our dedicated organization provides high-quality services in engineering, installation and maintenance to our customers across the UAE. Our extensive services include Fire alarm systems, Security systems, Emergency Lighting systems and all types of Fire Fighting systems. In our drive towards perfection and uncompromising quality we are constantly looking forward to building long-term customer relationship. The commitment and sincerity of our team is an integral factor of our success and reflects in every project we undertake. These values have seen us earn the trust of customers, suppliers and contractors. Eventually it is giving our customers true satisfaction – a factor that gives us pride and joy.

As the Chairman, I feel delighted to work with such a highly motivated and talented team. Hope this energy will reflect in every step we take towards the future.

I seek the wholehearted support of each of our patrons and hope that the rapport between us will continue to be bright, so that we could all grow together and make the world a better place to live in.

Chairman
Mr. Majid Obaid Juma Bin
Majid Al Falasi



CMD's MESSAGE – DUNES CAPITAL

It was in 2008 that I had an opportunity to give life to Dunes Capital Initiative. This was a result of my ambition and dream to create stunning and landmark structures. Since then, we have been in the forefront of building homes and structures, remaining completely committed to the society that we are a part of.

It all began with the launch of MAZ Consultants, a full-service consulting and engineering firm that offers public multi-disciplined expertise and comprehensive services. Once the foundation was set with the instant success of MAZ, Dunes Capital initiative was founded, and it soon becomes the mother company of all our initiatives.

Under the umbrella of Dunes Capital Initiative, we slowly moved towards other business verticals, on a mission to serve a wider ambit of requirements. MAF Fire Safety & Security was founded soon and it quickly developed into one of the most sought-after brands for fire & safety in the region. Gradually, Dunes Capital Initiative ventured into various sectors including Gas, Trading, Food sector, Retail sector, Property Development and MEP (Mechanical, Electrical and Plumbing) solutions.

At Dunes Capital Initiative, each project begins with an extensive dialogue with the client, so that we understand their requirements comprehensively. Our high-quality and cost-effective services include exploring multiple options to arrive at the best possible solutions. We specialize in civil engineering, architectural design, structural design, the design of fire fighting & fire alarm systems, building services design and project management services. We undertake commercial, industrial, residential land development, renovation, and conservation projects for Government, Corporations, and private owners. Our high-quality and cost-effective services include exploring multiple options to arrive at the best possible solutions.

We devote unmatched dedication to every single project of ours, irrespective of its size. Our services extend to research work, feasibility studies, case studies, preparation of tender drawings and documents, liaising with approving authorities, planning approval as well as construction supervision, start-up operation, project management, energy audit and management, professional management, and advisory services.

We look forward to your continued support and trust.

CMD Dunes Capital

Ar. Sulaiman Vayalath

B.Arch, F.I.I.A, Principle Architect



CEO's MESSAGE

Success is by no means an accident, but a result of continuous hard work, improvisation and yearning for the best. At MAF Fire Safety & Security, this pursuit for hard work is not simply a driving force, but also a routine practice strictly adhered by every single member of the group. That is exactly why MAF is one of the leading Fire & Safety brands in the UAE, that is greatly reputed and looked up by all our customers.

Ever since our inception in 2012, MAF has been growing steadily as a popular name in the sector. Despite stiff competition in the market, we have managed to make it to the top of the table through constant innovation of technology and introduction of new products and services. Thanks to our highly skilled and professional workforce, MAF has been successful in serving our customers with the best. Now, on a mission to serve a wider customer base, MAF is intending to reach out to other Emirates and even beyond. We hope to make our presence strong in the international market and make a global impact profoundly.

As the CEO, I am highly delighted to be a part of Team MAF and sincerely hope that the brand continues to grow higher in the months and years to come.

CEO

Mrs. Jasmin Sulaiman

MAF Fire Safety & Security



MAF FIRE SAFETY & SECURITY L.L.C

BUSINESS SEGMENTS

Now, as we celebrate our 5th anniversary, we are looking at larger prospects of expansion with new operations within the UAE, as well as other GCC countries including Oman, Qatar, Kuwait and Saudi Arabia. As an enterprise committed to customer welfare, we will soon be introducing more innovative and state-of-the-art products, with the pledge of prompt, round-the-clock service.

MAF Fire Safety & Security is one of the few companies in Dubai that has successfully secured DCD A+ category license. What is even more commendable, is the fact that we have gained this distinction within just 5 years of our inception, a feat so very laudable considering the fact that all other companies were able to manage it only after 10 years of operations.

PROJECT - A MISSION SO PROMISING!

MAF Fire Safety and Security LLC proud to say that, we have grown into what we are today because of our highly valued clients. Empowering them with the platinum value for their trust on us, we work according to their specific requirements, no matter the magnitude or scope of the task. We are passionate about what we do. All those little, yet crucial tasks involved in the designing of a complete fire system excites us. Thus, we would be happier to assist you right from the conceptual design stage of a project. This gives you an added advantage of having the benefit to avail our expertise right from stage one, so that your dream project will have a fire detection and protection setup of superlative standards.

The Design

We prepare the design drawings, which are to be submitted for approval based on the standards/specifications. MAF team design engineers who are proficient in typical fire protection system layouts.

As with the bids, the owner's engineering representative should thoroughly review the design drawings and flow calculations for technical compliance with the specifications. Final documents shall be submitted to the Civil defence (Local Authority for Jurisdiction) for approval after clearance from owner's representative.

Many contractors are not aware of the NFPA standards for specialized designs, such as turbine/generator protection, flammable liquids (storage/handling) and LPG tanks. In such cases, our expertise is available and can be used for the preparation of design drawings. The owner should then go-to-market for a bid for the installation based on our concept design drawings.

The Installation

Only after acceptance/approval has been obtained in writing from all review agencies, installation should begin. The failure to do so could result in major changes to the system that has already been installed. The installer would likely pass those additional costs to the owner. Fire safety practices should be in place during



installation, including good housekeeping and the proper supervision of hot and cold works. The owner's representative should make periodic progress inspections to check for non-conformance issues and good work practices.

Acceptance Evaluation

Acceptance evaluation of installed fire protection systems includes design and installation verification as well as acceptance testing. A final "walk-down" of the installation by an experienced fire protection specialist ensures that the systems is installed as per final approved design.

The specialist checks to make sure that no unauthorized or non-conforming changes have been made during the installation and that any field changes have been approved. The final verification includes all equipment and supporting devices which include functional tests of the components to prove the integrity of the complete fire detection and protection system.

Acceptance Testing

Even though fire protection systems cannot be tested under actual operating conditions, several steps need to be completed before a system can be considered as reliable and proper. Acceptance testing refers to the non-destructive tests that can be performed to assess the system's ability to meet the established performance criteria.

For water-based systems, this includes pipe flushing and hydrostatic tests, full trip testing of actuating valves and testing of all associated alarms. For gaseous fire suppression systems, this includes a complete operational (trip) test and the release of agent for carbon dioxide and clean agent fire suppression systems. A door fan test (Integrity Test) should be performed to assess the "tightness" of the protected space. Integrated system tests ensure that Fire suppression and detection systems working effectively.



ANNUAL MAINTENANCE CONTRACT.

Having problems with your existing fire fighting and fire alarm systems? Worry not!

We can help you by serving you with an Annual Maintenance Contract (AMC). You can avail our services 24/7/365 with the assurance of quick response and responsibility. As part of the AMC, we take over your existing system and closely monitor all crucial elements including Fire fighting, Fire detection and alarm, Emergency Lighting, Voice Evacuation and Gas suppression system. As part of the AMC, we also help our clients with the necessary documentation, clearances and periodic certifications that are required for compliance to local laws and regulations.

MAF comprises of a group of trained individuals, who make sure that all your life-saving products are working optimally. They do this through regular checks and updating all your devices. A quarterly report is sent to you so that you know the status of your system. All in all, MAF make sure that your equipment is ready to perform when you need it the most.

Why only authorized AMC

At MAF, we are manufacturing life-saving devices with passion and precision. We are best equipped to maintain them. Therefore, the law dictates that all fire and life safety equipment, must be serviced and maintained only by authorized personnel.

MAF AMC Package

MAF technical team has qualified, skilled and factory trained engineers & technicians who perform Quarterly Service Schedule for AMC customers to ensure that every equipment in the client's premises is ready to use and always working optimally.



BEFITTING FOR FIT OUT

As a service dedicated to all kinds of business segments, we offer specialized services for smaller spaces such as fit-outs, that operate as a part of a larger structure. This is crucial because, during an emergency, it is easier to spring into action and keep the space danger-free. Fit-outs start from the pre-approval by the licensing authority to plan your space and ends with the OC (occupancy certificate) and ready to move-in for your potential clients. We realize that time is money, so we always commit and follow through under all time constraints. All our projects are executed with our own in-house fit-out teams.

There are many regulations to adhere to when redefining an existing space of a structure/building. In order to comply with fire safety regulations, MAF team will work with you to provide advanced information about the fit-out jobs as per Civil Defence rules and regulations.



FOOL-PROOF RECTIFICATION

Building up a tamper-proof fire safety system is an expert task. Even the minutest of error would augment itself into a grave situation, rapidly. So, we have a 'check-up' system, for those who do not have AMC, which includes call-out maintenance, servicing and also, the replacement of fixtures, if required. We help you remain safe by correcting any flaw that occurs in your existing system with our exclusive rectification services. We offer you high-end rectification services so that you remain safe, by correcting any flaws that occur in your existing system and be doubly assured.

One of the most important elements of a commercial fit-out is the correct installation and maintenance of Fire and Safety Services. This involves qualified service specialists and is subject to strict regulations. These regulations are issued by the NFPA and Dubai Civil Defence includes Standards of Performance as well as the Standards of Maintenance. It is expected that as a client, you know and understand the responsibilities with regards to fire and safety at the commercial premises.

The client will do so by engaging a preferred Fire and Safety Services company to provide technical expertise and carry out installation as part of the overall fit out. The location and number of Fire sprinklers, installation of Emergency Warning, Inter-communication System, provision of Smoke Detectors, Manual call points and sounders are just some of the critical aspects of this work. The Fire and Safety technicians will ensure that all work is carried out in strict accordance with regulations and that the safety of those working within or near the premises is assured at all times.



APPLICATIONS

We offer products and solutions for a wide range of industries. With 5+ years of experience we have been able to develop unique fire-fighting solutions for many applications. These are some of the major and critical applications where our solutions are commonly used.

RESIDENTIAL & COMMERCIAL BUILDINGS, HOTELS & RESTAURANTS

The common type of fire fighting systems used in the buildings is automatic wet pipe sprinkler systems. In case of fire, the alarm valves act as check valves and give an alarm. The alarm is usually through the water gong audible alarm bell or through the signal from pressure or flow switch and the fire detection system and alarm system (since these systems are interfaced, as per local laws/regulations).

Pre-action alarm systems which have two signals in order to start water flow through a sprinkler system. It is especially of great use in the case of a false alarm or a mechanical failure. This is recommended in areas where sprinklers are necessary only in case of actual fire, so there is no water damage to any expensive assets in the building, due to inadvertent opening of sprinklers.

OIL, GAS & PETROCHEMICAL

Deluge water spray system for cooling of storage tanks, bullets, spheres, structures and flammable liquid storage areas. Fixed foam system for open top floating and fixed roof flammable liquid storage tanks. Foam bladder tank systems provide accurate, dependable, and cost-effective foam fire protection for a variety of flammable/combustible hazard areas, with no external power other than water pressure. Water is applied to the outside surface of the bladder, displacing foam the concentrate inside the bladder, which then is injected into the water stream. Deluge or compressed foam system for Generator room, Air craft Hangers and flammable liquid storage and handling areas. Custom engineered foam systems are ideal for foam proportioning applications for a range of foam discharge. The different range of Water/Foam monitors are used in petrochemical storage and refineries

MANUFACTURING PLANTS

The danger of Fire is critical in areas of manufacturing like paint booths, flammable liquid and paint storage areas, packing areas comprising of corrugated boxes, woods, boiler/ switchgear/ generator rooms, exhaust ducts, quench tanks, etc. In such places, fire detection and medium velocity water spray systems are used. Deluge or compressed foam systems are also commonly used in flammable liquid storage and handling areas. Custom engineered foam systems are used in special hazard areas.



POWER PLANTS

Deluge water spray system is commonly used in protecting places with steam gas and turbo generators, operating at high temperature and speed, containing a large quantity of lubricating oil that involve major risk of fire. For protecting any fixed hazards such as transformers, circuit breakers, diesel engines and diesel storage tanks, turbo alternators, lube oil systems, oil filled boilers; high-velocity water nozzle spray is used. Fire detection and medium velocity water spray systems are used in coal conveyor systems.

IRON AND STEEL INDUSTRIES

Iron and steel furnaces and heating chambers involve much fire hazards. The fixed water and foam fire protection system is able to quickly extinguish or suppress the fire and protect the surroundings until relevant personnel have full control of the situation.

AVIATION INDUSTRY AND AIRPORTS

Hangers – where aircraft are kept, are areas of potential risks keeping in mind the significant quantity of flammable liquid, etc. are present. Foam-water deluge systems, with supplementary protection like low-expansion foam discharge system using water powered oscillating monitors, are used in such places. Another option is a combination of automatic sprinkler protection and an automatic low-expansion foam system.

MARINE INDUSTRY

Taking into account the potential danger in terms of loss of lives and damage to cargo, fire hazard could be serious and crucial in vessels. We have a range of cast bronze monitors and aluminum bronze nozzles to nickel aluminum bronze deluge valves. They are the robust, rugged and very dependable type of fire-fighting products that are suitable for the marine type of environment.

PORTS AND TERMINALS

Foam –water sprinkler systems are the commonly used in high and medium risk areas in ports and docks like fertilizers, biomass, wooden boxes, chemicals, flammable liquids areas, etc. There are even other various portable foam discharge devices like mobile foam units, trailer mounted monitors are used in terminals.



METRO RAILWAYS

The fire characteristics in a metro tunnel are unique, different from those in buildings. The main fire load in a metro tunnel is the train itself and there is likelihood for the fire to spread along the cabin cars due to the effects of fire in the confined space. Unlike building fires, a train may still be in motion within a tunnel and the air in the tunnel may also be flowing due to the operation of the mechanical ventilation system. The consideration of fire safety in rail and in tramps, it has been increasing over recent years at a rapid rate. There are many steps of the requirement for fire protection that must be followed by metro rail operators. All systems including passenger compartments, electrical systems and switch cabinets pose lots of considerations for fire protection system during installation. With rail tunnel development booming worldwide, fire protection and safety measures have come to the forefront once again. With key technologies such as reaction-to-fire properties of rolling stock, fixed gas suppression systems, improved fire detection systems including video-based automatic incident detection systems and the automatic deployment of preset emergency plans, the industry tries to minimize the danger of tunnel fires.

SPECIAL PROJECTS

In addition to the design and manufacture of standard fire-fighting products, we can also provide customized and bespoke engineered systems to meet individual customer needs or applications for special projects. Special units and skids are made on demand according to your specifications. Our technical service and engineering teams can assist you on special project requirements for various fire-protection and related applications from initial conceptual design to commissioning and on-site assistance.



VISION AND MISSION

Our vision is to be recognized as the most trusted and reliable manufacturer and provider of industry standard and quality fire security products and services to our customers worldwide, that leverage advanced technology and performance, with value pricing and thereby achieving complete customer satisfaction. We work with a firm commitment to excel in all our operations by abiding to the fire safety principles, thus the trust that the people have in us, is truly what ignites us to excel.



We're proud to say that we have grown into what we are today because of our very special patrons – our clients. Empowering them with the platinum value for their trust on us, we work according to their specific requirements, no matter the magnitude or scope of the task. We offer various range of products required for any hazardous situations, even if it is a medium or high-risk application globally. Our post installation services like AMC and Rectification ensures that we aim only to safeguard the worldwide community from any kind of minutes.

We are persevering with hard work and conviction that our long-term strategies will have a positive impact on all those associated with us.

OUR VISION AND MISSION STATEMENTS



OUR CORE VALUES

Credibility

We keep our promises and meet our commitments. The courage to remain truthful ensures fairness in all our relationships.

Pride in our Employees

Our teams are the core of our business and ensure our future success. We must create a future together by nurturing and developing our staff.

People and Environment

We are fully committed to ensure an injury free workplace, where everybody goes home safe. Respect for people means to care for them and to protect the environment in which we live and work.

Customer Orientation

We commit ourselves to a long-term partnership focused on creating value and for our clients. Client satisfaction is achieved through the high quality of our teams and the services we provide.

Trust

We build relationships with clients, employees and consultants, on a foundation of trust and respect. We operate an open book approach with our clients and our goal is to develop long term relationships with our clients and become your partner of choice.



QUALITY ASSURANCE

The world around us has changed and continues to change, rapidly. In an increasingly uncertain world, MAF is increasingly certain about its responsibility as designers, engineers and managers of the build environment.

QUALITY POLICY

In order to create a better tomorrow MAF aims to:

- Meet the needs of its clients by providing services of recognized value.
- Seek continued enhancement of its performance through improved processes.
- Create continued where people of high ability are attracted to work in the firm.
- Achieve local delivery of the firm’s global knowledge and skills, supported by appropriate training and facilities.
- Maintain honour and mutual respect in relationships with clients, members of the firm and collaborators.



24X7 ASSISTANT



MAF comes to you with the exclusive advantage of round the clock service, every single day of the year. What we have in our kit, is a wide array of services that include Fire Fighting systems, Fire Alarm systems, Emergency Lighting systems, Gas installation and maintenance and Trading.

800 FIRE [800 3473]



HSE POLICY

HEALTH, SAFETY & ENVIRONMENTAL (HSE) POLICY We, at MAF, are committed to provide safe & healthy workplace and to take adequate measures to prevent Environmental pollution for its activities & services, so far as reasonably practical. To prevent any untoward incident / accident and ill-health to all employees, contractors and other stakeholders, MAF Top management recognizes HSE management as one of the top priorities for sustainable organizational growth.

To achieve this the company will, Incorporate HSE consideration in all its business decisions and operations of the organization, Promote awareness among its employees & contractors to develop a positive HSE culture, Provide information; impart training & instruction to its employees and contractors to ensure HSE requirements at job-sites including emergency & crisis management maintain equipment, office & job - site condition through optimal utilization of resource that minimize or eliminate occupational Health Safety & Environmental risk. Ensure contractors/suppliers are meeting the Project’s health and safety standards, optimize waste generation and encourage resource conservation and/or recycling, offer energy efficient/renewable energy solutions to the client where possible periodically review health and safety performance of the organization by business heads and ensure corrective actions are initiated. We believe, communication, consultation & collaboration with all employees and stakeholders and accountability at different level, shall uphold the principles of this policy.

All employees shall support the implementation of this management policy through – using the safety equipment issued to them, familiarizing them with the safety rules/procedures of the organization and by enforcing appropriate corrective measures, if violations are reported at site. The company with the coordination of all employees will endeavor for continual improvement in implementing HSE management & performance. MAF implemented this policy, in combination with Safety, Health Regulations, standards and codes of practice of our customers, in accordance with the applicable statutory requirements.



CSR POLICY





The initiatives put forward by MAF Fire Safety & Security LLC in Corporate Social Responsibility aims at imparting complete benefits to the society. It includes expanding organizational ethical codes, effective participation of employees and launching new programs and initiatives by holding company culture. CSR mainly presents its impression through charitable, philanthropic, environmental and volunteer based categories. It can also be the ultimate development process that includes effective participation of both public and private sectors. CSR has become a quite important facet of a private company's hierarchy that must be integrated to its mission and vision.

MAF Fire and Safety LLC.'s mission reflects its ethical codes and values in a way that are beneficial to the entire society. Our yearly goals consist of events and awareness campaigns to provide knowledge about the important issues and to enlighten people's lives.

We set goals to achieve social, voluntary, humane and charitable activities to benefit society and continuously evaluate them to develop to reach as many people.

MAF Fire and Safety LLC. Continuously engages in initiatives to make the world a better place to live in safely. We also focus on recognizing small time entrepreneurs with innovative ideas and concepts. Also, we coordinate with local organizations with its

Effective developmental and humanitarian investments and contribute in an effective manner. Our CSR implementation strategy will definitely make us a part in the development of the country with vision, environmental, human and voluntary goals, event calendars and we make partners with local entities that have similar goals.



ORGANIZATION CHART



KEY PERSONS

K
e
y
p
e
r
s
o
n
s



Majid Obaid Juma Bin Majid Al Falasi

Chairman



Sulaiman Vayalath

CMD



Jasmin Sulaiman

CEO



Mohamed Basheer

Executive Director



Riyas Parappammal

Director Business Development



Benzen Joy

HR



PRODUCTS





MAF FIRE DETECTION AND ALARM SYSTEM



SOLUTION F1 - 1 to 18 LOOPS



SOLUTION F2 - 1/2 LOOPS



Analogue Addressable and Conventional Devices

- Optical Smoke Detectors & Heat Detectors
- Multi-sensors - smoke/heat/CO (CO for addressable range only)
- IS Detectors - Flame Detectors (UV/IR)
- Single action/Dual action manual call points (incl weather proof)
- Manual Call Point (incl weather proof)
- Sounders (incl weather proof)
- Relay bases, Input/Output modules & Sounder bases



EMERGENCY LIGHTNING SYSTEM

MAF SELF-CONTAINED LUMINAIRES WITH SELFCONTROL



Rescue luminaires in various designs
 Emergency luminaires for flush-mounted or surface-mounted ceiling installations
 A dedicated battery for each escape sign and escape route luminaire.

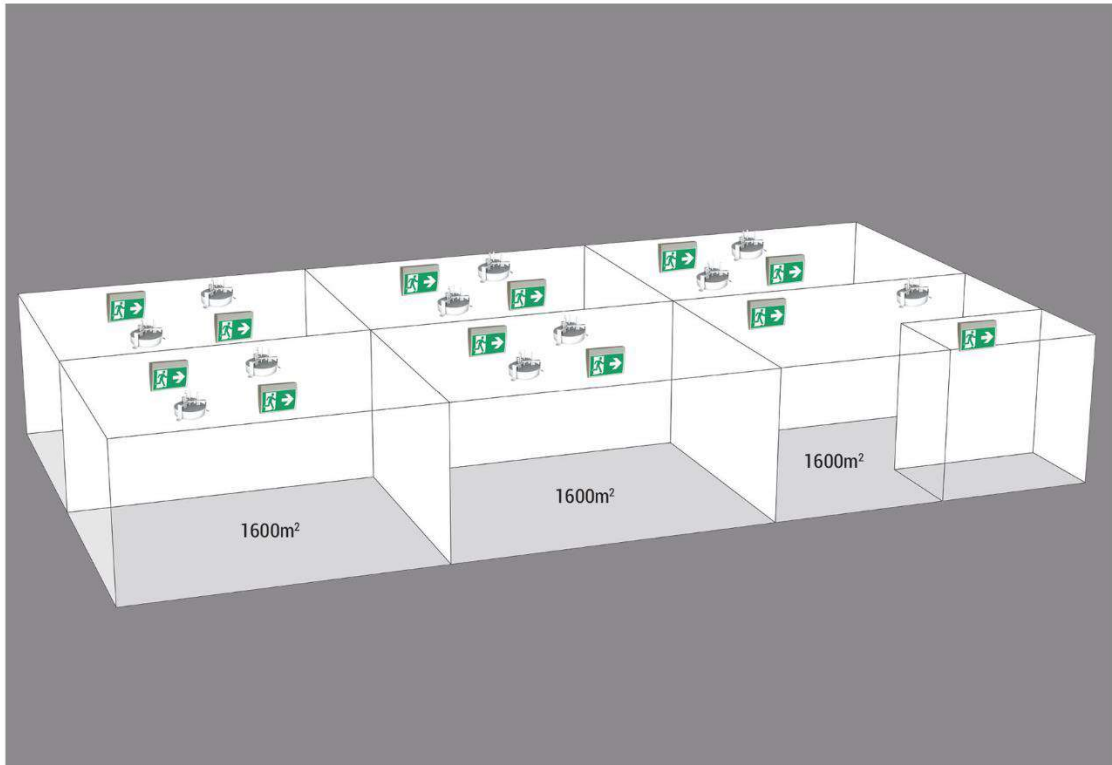

RADIO-CONTROLLED LUMINAIRES

MAF RADIO-CONTROLLED SAFETY LIGHTING WITH WIRELESS PROFESSIONAL AND WIRELESS BASIC



Low installation costs and total costs

Lights communicate with one another via integrated modules

Energy saving potential (lights can be switched according to a timetable or manually)

Network Wireless Professional 868 MHz / Wireless Basic® 2,4GHz

Central set-up and maintenance via Android tablet or smartphone

Storing of all relevant data and test reports in the Cloud (LIGHTLINX®)

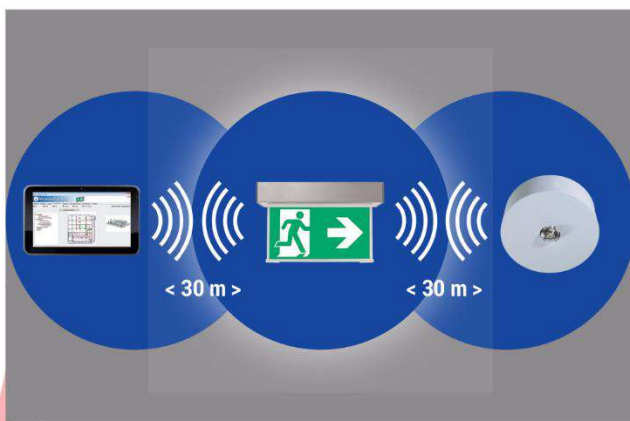

Wireless luminaire monitoring and control with Wireless Professional (left) and Wireless Basic® (right)

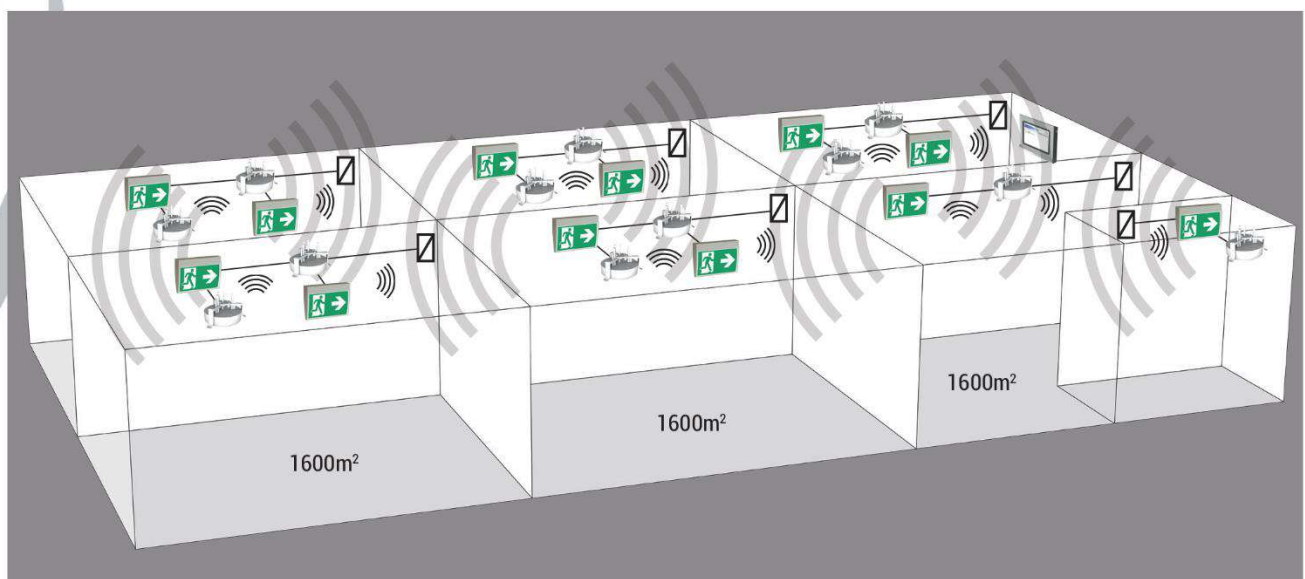

Example of an industrial hall with virtual fire zones



CENTRAL BATTERY SYSTEMS (CBS)

MAF LUMINAIRES WITH CENTRAL BATTERY SYSTEMS (CBS)



A large power supply system for up to 96 circuits
 Installation in a dedicated electrical plant room
 One set of batteries for the central system
 Single luminaire monitoring.

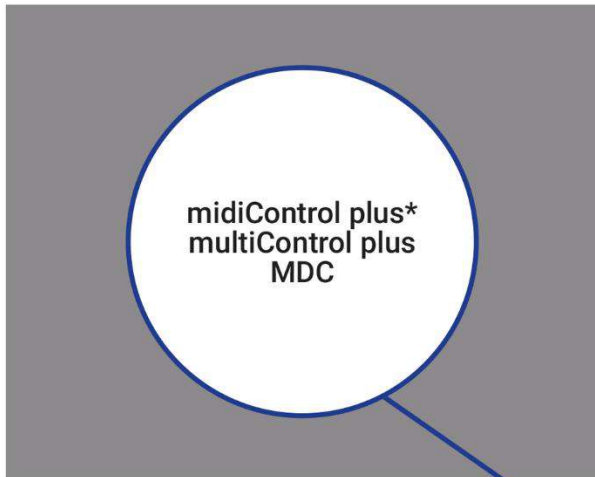

Power supply installation, as e. g. multiControl plus

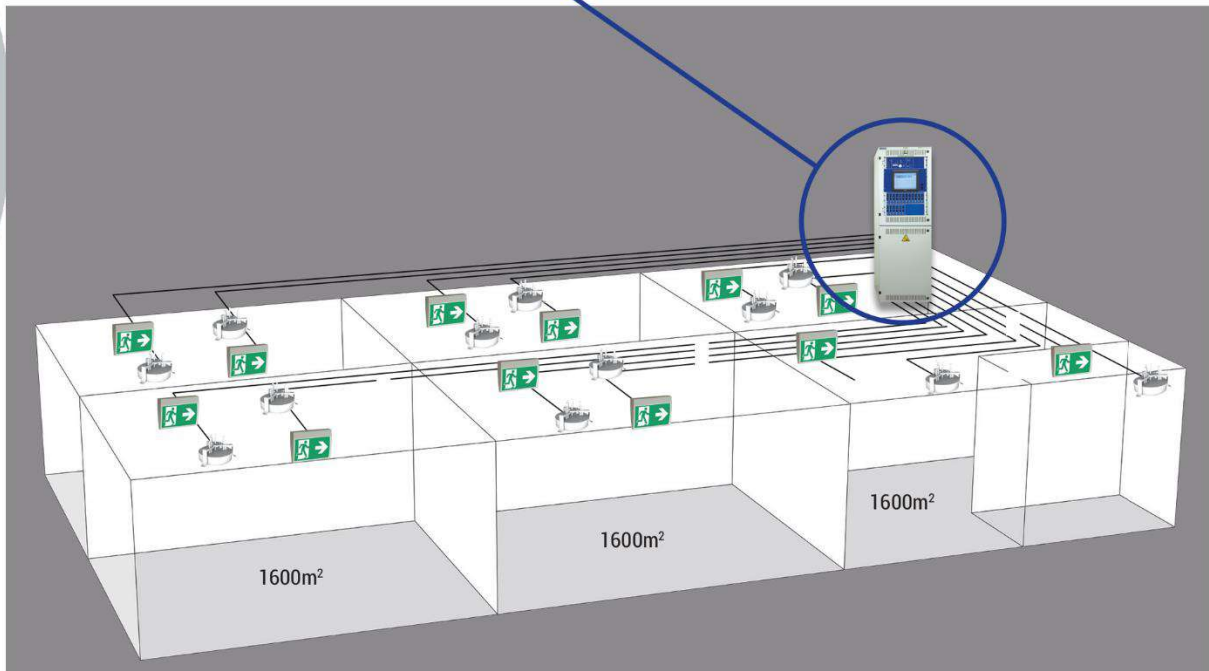

LOW POWER SYSTEMS (LPS)

MAF LUMINARIES WITH DE CENTRALIZED LOW POWER SYSTEMS (LPS)



- A dedicated small power supply system for each fire zone
- One master system and multiple slave systems
- Each system has dedicated batteries
- No E30 cabling necessary
- Single luminaire monitoring

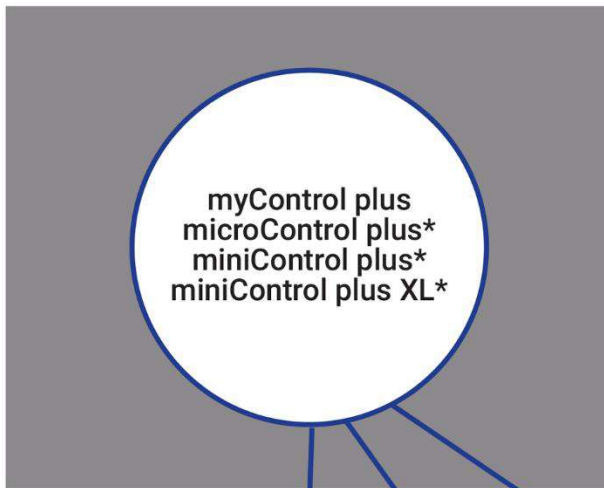

Power supply installation, as e. g. miniControl plus*

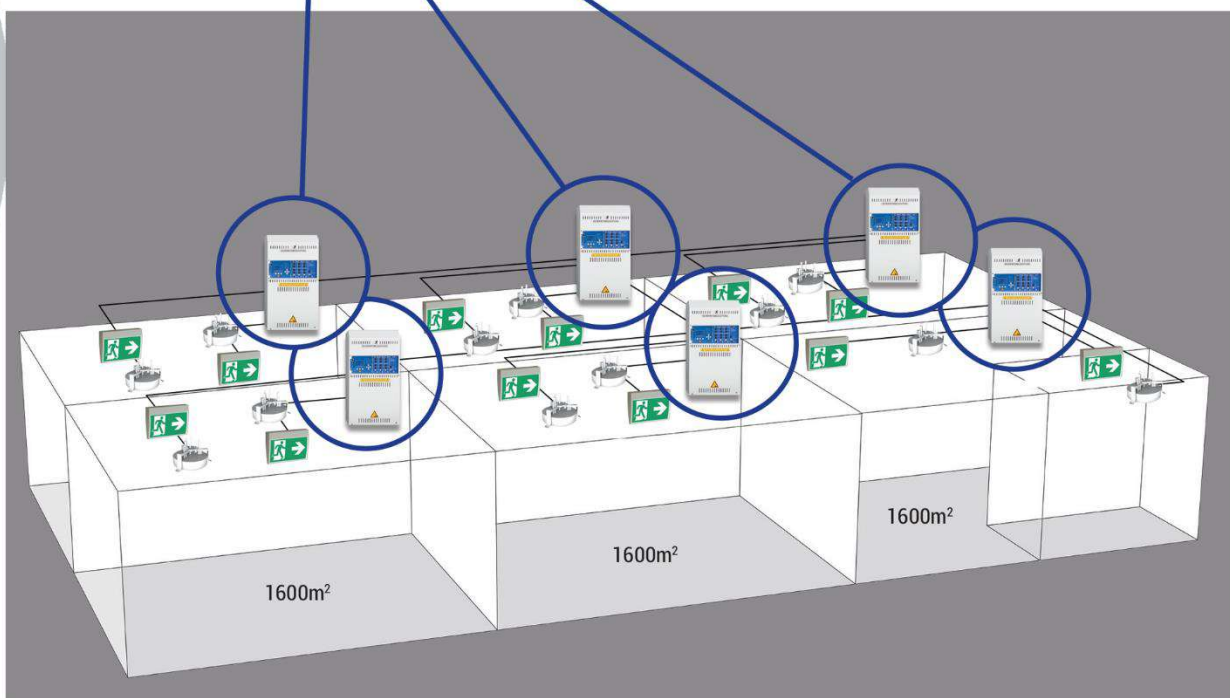

GAS CONTROL PANEL

BOSEAN GAS SYSTEM



Addressable and conventional multi zone control panels
 24V DC Multi gas sensors (explosion and water proof)
 220V Domestic gas detectors
 220V Domestic stand alone detectors



SITERWELL ALARM SYSTEM

UL APPROVED FIRE ALARM SYSTEM



System Composition Diagram

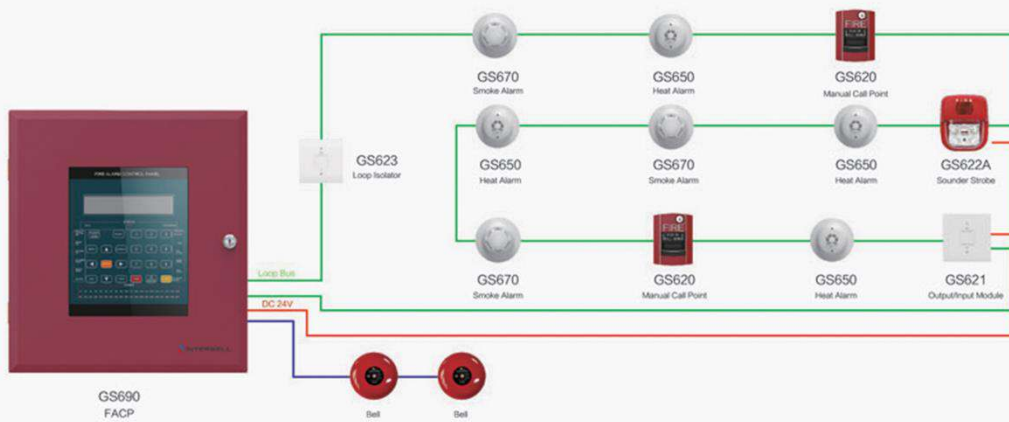

KITCHEN FIRE EXTINGUISHING SYSTEMS

DEFENDER MECHANICAL KITCHEN FIRE EXTINGUISHING SYSTEMS



- DM 8 : 8 flows point fire suppression system
- DM12 : 12 flows point fire suppression system
- DM18 : 18 flows point fire suppression system

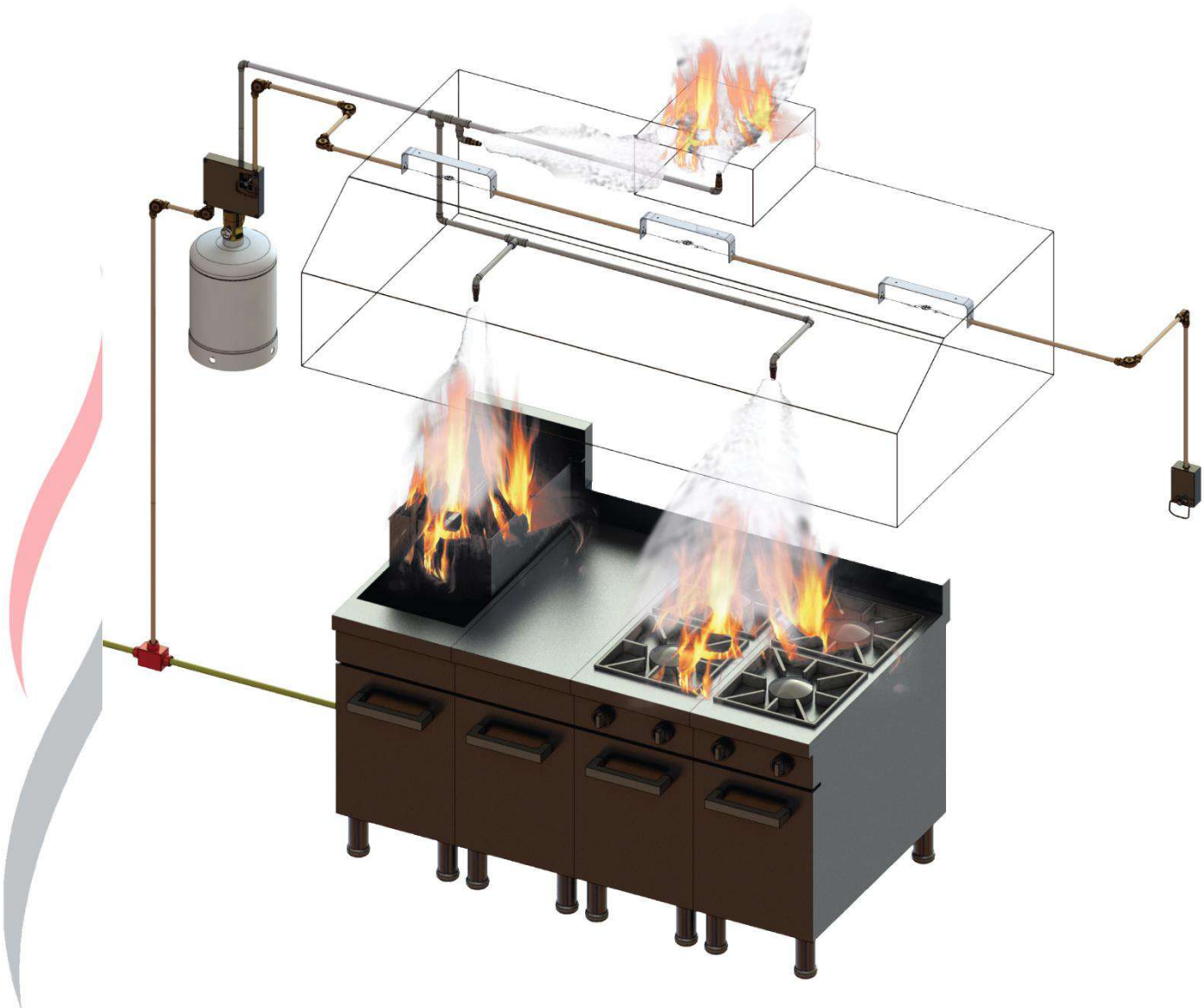

CO2 EXTINGUISHER

MAF CO2, MED, DNV & LPCB EN3 EXTINGUISHER



- 2KG CO2 EN3 EXTINGUISHER - KITE MARK BSI
- 5KG CO2 EN3 EXTINGUISHER - KITE MARK BSI
- 2KG CO2 DNV EXTINGUISHER
- 5KG CO2 DNV EXTINGUISHER
- 5KG CO2 MED EXTINGUISHER
- 2KG CO2 LPCB EN3 EXTINGUISHER
- 5KG CO2 LPCB EN3 EXTINGUISHER
- 10kg CO2 KITE MARK BSI



ABC POWDER EXTINGUISHER

MAF ABC - EN3, MED & DNV EN3 EXTINGUISHER



1KG 40% ABC - EN3 & DNV POWDER
 1KG 30% ABC - EN3 & DNV POWDER
 1KG 70% ABC - EN3 & DNV POWDER
 2KG 40% ABC - EN3 & DNV POWDER
 2KG 30% ABC - EN3 & DNV POWDER
 2KG 70% ABC - EN3 & DNV POWDER
 3KG 30% ABC - EN3 & DNV POWDER
 4KG 40% ABC - EN3 & DNV POWDER
 4KG 30% ABC - EN3 & DNV POWDER
 6KG 40% ABC - EN3 & DNV POWDER

6KG 30% ABC - EN3 & DNV POWDER
 6KG 50% ABC - EN3 & DNV POWDER
 6KG 70% ABC - EN3 & DNV POWDER
 9KG 40% ABC - EN3 & DNV POWDER
 9KG 30% ABC - EN3 & DNV POWDER
 9KG 70% ABC - EN3 & DNV POWDER
 6KG 70% ABC - MED EXTINGUISHER
 9KG 70% ABC - MED EXTINGUISHER
 25KG/30KG 40% ABC TROLLEY TYPE
 50KG 40% POWDER TROLLEY TYPE



FOAM EXTINGUISHER

MAF AFFF - EN3 FOMTEC DNV & MED FOAM EXTINGUISHER



- 2L 3% AFFF - EN3 FOAM
- 3L 3% AFFF - EN3 FOAM
- 6L 3% AFFF - EN3 FOAM
- 9L 3% AFFF - EN3 FOAM
- 6L 3% AFFF - DNV EN3 FOAM
- 9L 3% AFFF - DNV EN3 FOAM
- 6L 5% AFFF FOMTEC DNV EN3
- 9L 5% AFFF FOMTEC DNV EN3
- 6L 15% INILAM FOAM MPA EN3
- 9L 15% INILAM FOAM MPA EN3
- 9L 3% AFFF - MED FOAM
- 25L 3% AFFF - EN3 FOAM
- 50L 3% AFFF - EN3 FOAM



WATER EXTINGUISHER

MAF WATER MED, EN3 & DNV EXTINGUISHER



- 6L WATER EN3 EXTINGUISHER
- 9L WATER EN3 EXTINGUISHER
- 9L WATER DNV EN3 EXTINGUISHER
- 9L WATER MED EXTINGUISHER



WET CHEMICAL EXTINGUISHER

MAF WET CHEMICAL EN3 EXTINGUISHER



2L WET CHEMICAL EN3 EXTINGUISHER
6L WET CHEMICAL EN3 EXTINGUISHER



CO2 EXTINGUISHER

ORIENTX CO2, MED, DNV & LPCB EN3 EXTINGUISHER



- 2KG CO2 EN3 EXTINGUISHER - KITE MARK BSI
- 5KG CO2 EN3 EXTINGUISHER - KITE MARK BSI
- 2KG CO2 DNV EXTINGUISHER
- 5KG CO2 DNV EXTINGUISHER
- 5KG CO2 MED EXTINGUISHER
- 2KG CO2 LPCB EN3 EXTINGUISHER
- 5KG CO2 LPCB EN3 EXTINGUISHER
- 10kg CO2 KITE MARK BSI



ABC POWDER EXTINGUISHER

ORIENTX ABC - EN3, MED & DNV EN3 EXTINGUISHER



1KG 40% ABC - EN3 & DNV POWDER
 1KG 30% ABC - EN3 & DNV POWDER
 1KG 70% ABC - EN3 & DNV POWDER
 2KG 40% ABC - EN3 & DNV POWDER
 2KG 30% ABC - EN3 & DNV POWDER
 2KG 70% ABC - EN3 & DNV POWDER
 3KG 30% ABC - EN3 & DNV POWDER
 4KG 40% ABC - EN3 & DNV POWDER
 4KG 30% ABC - EN3 & DNV POWDER
 6KG 40% ABC - EN3 & DNV POWDER

6KG 30% ABC - EN3 & DNV POWDER
 6KG 50% ABC - EN3 & DNV POWDER
 6KG 70% ABC - EN3 & DNV POWDER
 9KG 40% ABC - EN3 & DNV POWDER
 9KG 30% ABC - EN3 & DNV POWDER
 9KG 70% ABC - EN3 & DNV POWDER
 6KG 70% ABC - MED EXTINGUISHER
 9KG 70% ABC - MED EXTINGUISHER
 25KG/30KG 40% ABC TROLLEY TYPE
 50KG 40% POWDER TROLLEY TYPE



FOAM EXTINGUISHER

ORIENTX AFFF - EN3 FOMTEC DNV & MED FOAM EXTINGUISHER



- 2L 3% AFFF - EN3 FOAM
- 3L 3% AFFF - EN3 FOAM
- 6L 3% AFFF - EN3 FOAM
- 9L 3% AFFF - EN3 FOAM
- 6L 3% AFFF - DNV EN3 FOAM
- 9L 3% AFFF - DNV EN3 FOAM
- 6L 5% AFFF FOMTEC DNV EN3
- 9L 5% AFFF FOMTEC DNV EN3
- 6L 15% INILAM FOAM MPA EN3
- 9L 15% INILAM FOAM MPA EN3
- 9L 3% AFFF - MED FOAM
- 25L 3% AFFF - EN3 FOAM
- 50L 3% AFFF - EN3 FOAM



WATER EXTINGUISHER

ORIENTX WATER MED, EN3 & DNV EXTINGUISHER



- 6L WATER EN3 EXTINGUISHER
- 9L WATER EN3 EXTINGUISHER
- 9L WATER DNV EN3 EXTINGUISHER
- 9L WATER MED EXTINGUISHER



WET CHEMICAL EXTINGUISHER

ORIENTX WET CHEMICAL EN3 EXTINGUISHER



2L WET CHEMICAL EN3 EXTINGUISHER
6L WET CHEMICAL EN3 EXTINGUISHER



MAF FEU FIRE RESISTANT CABLE

MAF FEU LPCB FIRE RESISTANT CABLE



2 CORE : 1 sq mm, 1.5 sq mm, 2.5 sq mm

3 CORE : 1 sq mm, 1.5 sq mm, 2.5 sq mm

4 CORE : 1 sq mm, 1.5 sq mm, 2.5 sq mm

100 M REELS (RED / WHITE)

300 M REELS (RED / WHITE)

500 M REELS (RED / WHITE)



FIRE RESISTANT CABLE

TIANJIE UL FIRE RESISTANT CABLE



2 CORE : 1 sq mm, 1.5 sq mm, 2.5 sq mm

3 CORE : 1 sq mm, 1.5 sq mm, 2.5 sq mm

4 CORE : 1 sq mm, 1.5 sq mm, 2.5 sq mm

100 M REELS (RED / WHITE)

300 M REELS (RED / WHITE)

500 M REELS (RED / WHITE)



FIRE HOSE REEL

IMSECUR LPCB AND CE FIRE HOSE REEL



MANUAL & SWINGING FIRE HOSE REEL AUTOMATIC & SWINGING FIRE HOSE REEL



FIRE HOSE

IRON MAN UL AND CE FIRE HOSE



SINGLE EPDM JACKET FIRE HOSE (HOSE SIZES (inch) : 1.5, 2 & 2.5)
 DOUBLE EPDM JACKET FIRE HOSE (HOSE SIZES (inch) : 1.5 & 2.5)
 SINGLE JACKET NBR/PVC FIRE HOSE (HOSE SIZES (inch) : 1.5 & 2.5)



FIRE FIGHTING VALEVES

APC UL FLANGED,GROOVED & X FLANGED END VALVES



FLANGED END GATE VALVE
 FLANGED X GROOVED END GATE VALVE
 GROOVED END GATE VALVE
 SWING CHECK VAKVE
 GROOVED SWING CHECK VALVE



FIRE FIGHTING BUTTERFLY VALVE

APC UL HYDRANT & INDICATOR



GROOVED TYPE BUTTERFLY VALVE
PROTECTION TYPE BUTTERFLY VALVE
WAFER TYPE BUTTERFLY VALVE



FIRE FIGHTING HYDRANT & INDICATOR

APC UL HYDRANT & INDICATOR



DRY BARREL FIRE HYDRANT
VERTICAL TYPE INDICATOR
WALL TYPE INDICATOR



AUTOMATIC SPRINKLERS

PD UL AND FM SPRINKLERS



UPRIGHT AND PENDENT STANDARD-SPARY SPRINKLERS
STANDARD SIDEWALL SPRAY SPRINKLERS
FLUSH, RECESSED AND CONCEALED SPRINKLERS

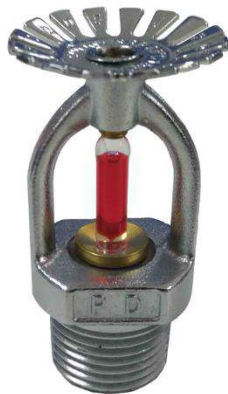

METALLIC SPRINKLER PIPES

TUS UL AND FM SPRINKLER PIPES



SCHEDULE 40 (BLACK, RED OR GALVANIZED) STEEL SPRINKLER PIPE

SIZES(Inch): 1/2, 3/4, 1, 1-1/4, 1-1/2, 2, 2-1/2, 3, 4, 6, 8 & 10

SCHEDULE 10 (BLACK, RED OR GALVANIZED) STEEL SPRINKLER PIPE

SIZES(Inch): 1, 1-1/4, 1-1/2, 2, 2-1/2, 3, 3-1/2, 4, 6, 8 & 10



LPG TANK REMOTE MONITORING SOLUTIONS

MAF ZERO RADIO TUV AND CE



Level monitoring
Precise plant localization
Fraud control, not authorized refilling

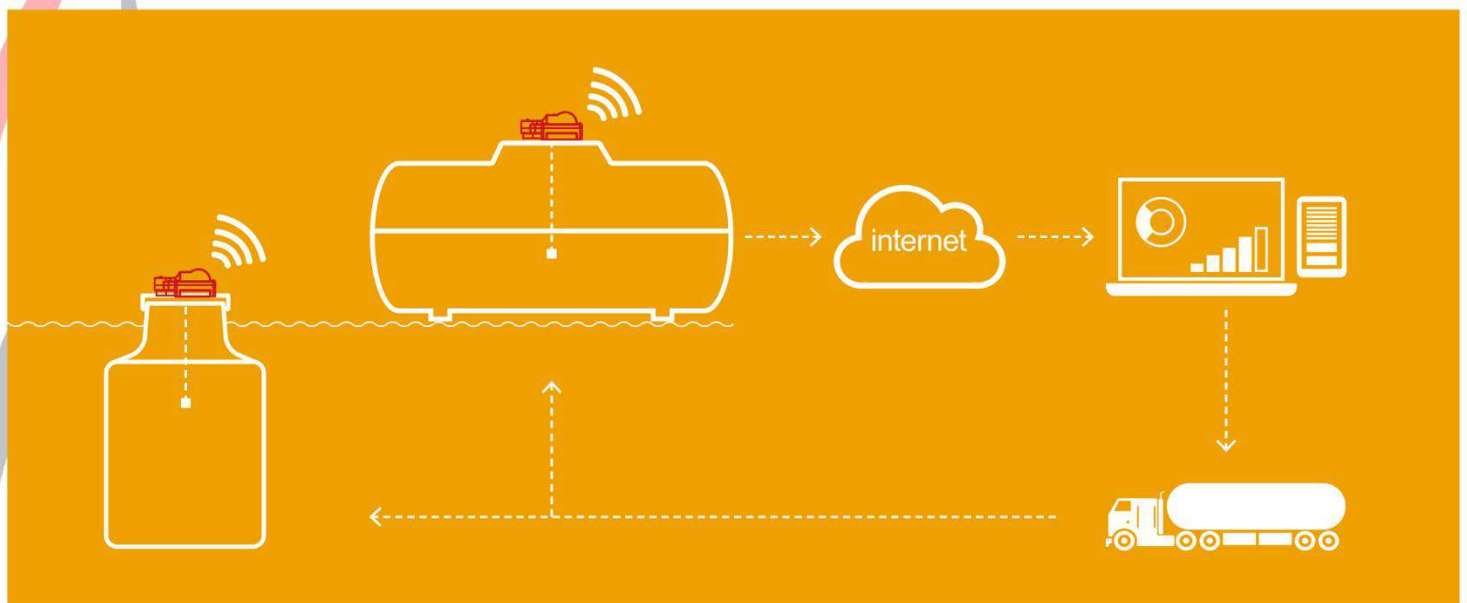

LICENSES & CERTIFICATES

Note: All Licenses and Certificates are valid and current at the time of preparation of this document. The same can be inspected at our Head Office



TRADE LICENCE

DUBAI – ABU DHABI - SHARJAH





رخصة تجارية Commercial License

تفاصيل الرخصة / License Details

License No.	677538	رقم الرخصة
Company Name	MAF FIRE SAFETY & SECURITY L.L.C	اسم الشركة
Trade Name	MAF FIRE SAFETY & SECURITY L.L.C	الإسم التجاري
Legal Type	Limited Liability Company(LLC)	الشكل القانوني
Expiry Date	10/10/2021	تاريخ الإصدار
D&B D-U-N-S ®	0	رقم الرخصة الام
Register No.	1103288	عضوية الغرفة
	تاريخ الإنتهاء	Issue Date
	رقم العالمي	Main License No.
	رقم السجل التجاري	DCCI No.

الاطراف / License Members

Share / الحصص	Role / الصفة	Nationality / الجنسية	Name / الإسم	No./رقم الشخص
	Manager / مدير	India / الهند	جاسمين سليمان سليمان فايلات	466354
			JASMIN SULAIMAN SULAIMAN VAYALATH	

نشاط الرخصة التجارية / License Activities

Fire Fighting & Safety Equipment Trading	تجارة معدات واجهزة السلامة واطفاء الحريق
Fire Fighting Safety Equipment Installation	تركيب معدات السلامة واطفاء الحريق

العنوان / Address

Phone No	971-4-2397910	تليفون	P.O. Box	49895	صندوق بريد
Fax No	971-4-2398710	فاكس	Parcel ID	248-6496	رقم القطعة
Mobile No	971-50-2385622	هاتف متحرك			مستودع 5 ملك مؤسسة دبي العقارية - القصيص

البريد الإلكتروني / Email info@mafsafety.ae

الملاحظات / Remarks

يمنع مزاولة نشاط الشركة الخاص بالدفاع المدني قبل أخذ موافقة الادارة العامة للدفاع المدني- دبي
The Company Shall not Carry on The DCD activities unless approved by Dubai Civil Defence

Print Date 12/10/2020 9:33 تاريخ الطباعة

Receipt No. 13679894 رقم الإيصال



يمكنك الآن تجديد رخصتك التجارية من خلال الرسائل النصية القصيرة، أرسل رقم الرخصة إلى 6969 (دو/اتصالات) للحصول على اذن الدفع.
Now you can renew your trade license by sending a text message (SMS). Send your trade license number to 6969 (Du/ Etisalat) to receive payment voucher.

وثيقة إلكترونية معتمدة وصادرة بدون توقيع من دائرة التنمية الاقتصادية. لمراجعة صحة البيانات الواردة في الرخصة برجاء زيارة الموقع www.dubaided.gov.ae
Approved electronic document issued without signature by the Department of Economic Development. To verify the license kindly visit www.dubaided.gov.ae

شهادة تسجيل العضوية
Membership Certificate

License no.	677538	رقم الرخصة	677538
Membership no.	211535	رقم العضوية	211535
Registration no.	1103288	رقم السجل التجاري	1103288
Trade Name	MAF FIRE SAFETY AND SECURITY L.L.C	الاسم التجاري	ماف الحريق الامن والسلامة ش.ذ.م.م
Legal Status	Limited Liability Company(LLC)	الشكل القانوني	ذات مسؤولية محدودة
Activity	Fire Fighting Safety Equipment Installation Fire Fighting & Safety Equipment Trading	نوع النشاط	تركيب معدات السلامة واطفاء الحريق تجارة معدات واجهزة السلامة واطفاء الحريق
Member Since	11/10/2012	تاريخ الإنتساب	11/10/2012
Date of Issue	11/10/2012	تاريخ الإصدار	11/10/2012
Expiry Date	10/10/2021	تاريخ الإنتهاء	10/10/2021

Remarks

This certificate shall be invalid incase of any alteration without chamber's authorization

For online verification of this Certificate, please visit our website
<http://www.dubaichamber.ae/verify>

غرفة تجارة وصناعة دبي
Dubai Chamber of Commerce & Industry

P.O. Box 1457 - Dubai, U.A.E. | Tel (Within UAE) 800 CHAMBER (800 2426237) | Tel (Outside UAE) (+971) 4 2280000 هـاتف
فاكس (+971) 4 2211646 | customercare@dubaichamber.ae | www.dubaichamber.ae

الملاحظات

تعتبر هذه الشهادة لاغية في حال أي كسب أو تعديل عليها دون اعتماد ذلك من الغرفة

للتأكد من صحة بيانات الشهادة يرجى الرجوع إلى موقع الغرفة
<http://www.dubaichamber.ae/verify>



رخصة تجارية Commercial License

تفاصيل الرخصة / License Details

License No.	635179		رقم الرخصة
Trade Name	MAF FIRE & SAFETY EQUIPMENT GENERAL TRADING		الإسم التجاري
Legal Type	Sole Establishment	مؤسسة فردية	الشكل القانوني
Expiry Date	17/02/2021	تاريخ الإنتهاء	تاريخ الإصدار
D&B D-U-N-S @ N	0	الرقم العالمي	رقم الرخصة الام
Register No.	1054943	رقم السجل التجاري	عضوية الغرفة
		Issue Date	18/02/2010
		Main License No	635179
		DCCI No.	180541

الاطراف / License Members

Share / الحصص	Role / الصفة	Nationality / الجنسية	Name / الإسم	رقم الشخص/No.
	Est. Owner / مالك مؤسسة	United Arab Emirates / الامارات	محمد عيسى محمد السميت	25229
	Manager / مدير	India / الهند	MOHAMMAD ESSA MOHAMMAD ALSAMT JASMIN SULAIMAN SULAIMAN VAYALATH	466354

نشاط الرخصة التجارية / License Activities

General Trading	تجارة عامة
Fire Fighting & Safety Equipment Trading	تجارة معدات واجهزة السلامة واطفاء الحريق

العنوان / Address

Phone No	971-4-2546325	تليفون	P.O. Box	49895	صندوق بريد
Fax No	971-4-2546326	فاكس	Parcel ID	129-289	رقم القطعة
Mobile No	971-55-9987303	هاتف متحرك	مكتب رقم 1 ملك محمد جعفر الشيخ عبدالحسين رضا الانصاري - ديره/بورسعيد		

الملاحظات / Remarks

تم تغيير الموقع في 21/2/2017
يمنع مزاوله نشاط الشركة الخاص بالدفاع المدني قبل أخذ موافقة الادارة العامة للدفاع المدني- دبي
The Company Shall not Carry on The DCD activities unless approved by Dubai Civil Defence

Print Date 10/02/2020 17:47 تاريخ الطباعة Receipt No. 13463461 رقم الإيصال

يمكنك الآن تجديد رخصتك التجارية من خلال الرسائل النصية القصيرة، أرسل رقم الرخصة إلى 6969 (دو/اتصالات) للحصول على اذن الدفع.

Now you can renew your trade license by sending a text message (SMS). Send your trade license number to 6969 (Du/ Etisalat) to receive payment voucher.

وثيقة إلكترونية معتمدة وصادرة بدون توقيع من دائرة التنمية الاقتصادية. لمراجعة صحة البيانات الواردة في الرخصة برجاء زيارة الموقع www.dubaided.gov.ae

Approved electronic document issued without signature by the Department of Economic Development. To verify the license kindly visit www.dubaided.gov.ae

Commercial License

Emerging Economic Establishment

رخصة تجارية

منشأة اقتصادية ناشئة

License No	:	CN-2529525	:	رقم الرخصة
ADCCI No	:	2587144	:	عضوية الغرفة
Establishment Card MOHRE	:	950272	:	وزارة الموارد البشرية والتوطين بطاقة المنشأة
Establishment Card GDRFA	:		:	الإدارة العامة للإقامة وشؤون الأجناب - بطاقة المنشأة
Legal Form	:	UAE Branch - Dubai	:	الشكل القانوني
			:	فرع اماراتية - دبي
			:	ماف الحريق الامين والسلامة ش ذ م م - فرع أبو ظبي 1
Trade Name	:	MAF FIRE SAFETY & SECURITY LLC - BRANCH OF ABU DHABI 1	:	الإسم التجاري
Establishment Date	:	25/04/2018	:	تاريخ تأسيس المنشأة
Issue Date	:	18/06/2020	:	تاريخ الإصدار
Expiry Date	:	17/06/2021	:	تاريخ الإنتهاء

الصلة Role	الجنسية Nationality	الملاك / الشركاء Owners / Partners	الرمز No.
مالك Owner	دولة الإمارات العربية المتحدة United Arab Emirates	ماف الحريق الامين والسلامة ش ذ م م - فرع أبو ظبي 1 MAF FIRE SAFETY & SECURITY LLC - BRANCH OF ABU DHABI 1	677538

Commercial Activities	:	الأنشطة التجارية
- Installation and repair of safety equipment and fire extinguishing systems		- تركيب وأصلاح نظم معدات السلامة و إطفاء الحريق
- Wholesale of Safety and Fire Fighting Equipment and Devices Trading		- تجارة معدات واجهزة السلامة واطفاء الحريق - بالجملة
- Retail Sale of Safety and Fire Fighting Equipments and Devices		- بيع معدات واجهزة السلامة واطفاء الحريق - بالتجزئة
Address	:	العنوان
	:	المصنف, م 0,45 : ~, مبنى, سمو الشيخ عبدالله بن زايد ال نهيان و اخرين
	:	(تم تحصيل رسوم خدمات الدفاع المدني)

وثيقة معتمدة وصادرة بدون توقيع أو ختم من دائرة التنمية الاقتصادية - أبوظبي. للتحقق من صحة البيانات الواردة في الرخصة برجاء زيارة الموقع <http://www.ded.abudhabi.ae>

Approved document issued without signature or stamp by the Department of Economic Development - Abu Dhabi. To verify the license kindly visit <http://www.ded.abudhabi.ae>

Official Email	:	hr@mafsafety.ae	:	البريد الإلكتروني الرسمي
Official Mobile	:	971524959449	:	رقم التواصل الرسمي





رخصة تجارية
Trading License



Issue Date		تاريخ الإصدار		License No.		رقم الرخصة	
Expiry Date		تاريخ الإنتهاء		Registration No.		رقم السجل	
2020/01/28		2020/01/28		771571		771571	
2021/01/28		2021/01/28		190618		190618	
Trade Name		MAF FIRE SAFETY & SECURITY L.L.C - SHJ. BR		الإسم التجاري		ماف الحريق الامن والسلامة ش.ذ.م.م - فرع الشارقة	
Legal status		Branch for Local Company		الشكل القانوني		فرع لشركة محلية	

أطراف الرخصة License Members

الحصص	الصفة	رقم الهوية / الجواز	الجنسية	إسم المستثمر	رقم المستثمر
Shares	Type	ID/Passport No.	Nationality	Investor Name	Investor No.
%51	شريك	784196732791577	الإمارات	ماجد عبيد جمعه بن ماجد الفلامي	4814513
%49	شريك	784197802650594	الهند	جاسمين سليمان سليمان فايلات	4814511

أنشطة الرخصة: تركيب وأصلاح نظم معدات السلامة و إطفاء الحريق. بيع معدات واجهزة السلامة واطفاء الحريق - بالتجزئة. مكتب
العنوان: الشارقة-موبلج/الشارقة- خلف شارع الشيخ محمد بن زايد -مكتب رقم 103 طبق رقم 1 ملك خليفه راشد عبد الله محيان الكتبي

رقم الهاتف المتحرك: 0559987303
صندوق البريد: 49895 الشارقة



2020/01/28

54624

تاريخ الطباعة

رقم المستخدم

CIVIL DEFENCE CERTIFICATES

DUBAI – ABU DHABI - SHARJAH





ترخيص تركيب وصيانة الفئة الاولى A (لأنظمة الحماية و المكافحة)

رقم الترخيص
License Number
MCTNA0000074374-2017

عدد التراخيص
Number of Licenses
1-1

رقم التسجيل
Registration Number
1103288

رقم الترخيص
License Number
677538

رقم المنشأة
Name of Establishment
ماف الحريق الامن والسلامة ش.م.م.

اسم صاحب الترخيص
Owner of the License
ماجد عبيد جمعة بن ماجد الفلاسي

اطراف الرخصة
Partner in the License
جاسمين سليمان سليمان فليلات

رقم الهاتف
Office Phone Number
971-4-2397910

عنوان الشركة
Company Address
مستودع 5 ملكة موسسة دبي العقارية - القصيص

الموقع / البريد الإلكتروني
Email of the Company
info@majsafety.ae

تاريخ الانتهاء
License Expired
2021/06/16م

تاريخ الإصدار
License Issued
2020/07/16

تأسست بتاريخ
Company Registered Date
2012/10/11م

مجال الترخيص
Licensing Field
نظام الحماية و المكافحة

عدد المهندسين المعتمدين
Number of Approved Engineers
24

عدد الفنيين المعتمدين
Number of Approved technicians
6

تم اصدار الترخيص استناداً إلى القرار الوزاري رقم (213) لسنة 2017، في شأن تنظيم خدمات الدفاع المدني
The license was issued pursuant to Ministerial Decree No. (213) for the year 2017 pertaining the regulation of civil defense services





Tel : 04 - 2611111
Fax : 04 - 2612449
P.O. Box 11377, Dubai
United Arab Emirates
www.dcd.gov.ae

للطوارئ
EMERGENCY
997

الرؤية:
أن تكون دولة الإمارات العربية المتحدة من
أفضل دول العالم في تحقيق الأمن والسلامة.

Vision:
To have the United Arab Emirates as one of the best
countries in the world in achieving safety and security.

رقم الترخيص
License Number

MCTNA0000074374-2017

اسم المنشأة
Name of Establishment

ماف الحريق الامن والسلامة ش.م.م

عدد التراخيص
Number of Licenses

1 - 1

نوع المشاريع المنفذة
Implemented projects Type

*حجم المشاريع
عدد غير محدد من الطابق غير محدد المساحة

كشف المعدات والأجهزة والمواد المعتمدة المراد صيانتها
List of approved equipments to be maintained

م	تركيب وصيانة أنظمة الحماية	م	تركيب وصيانة أنظمة المكافحة
1	أجهزة الإنذار (لوحة تحكم/كواشف/كاسر زجاج/ نظام الإخلاء الصوتي)	1	طفايات حريق يدوية/مضخات حريق/الصواعد/ مرشات/خرطوم الحريق/فوهات الحريق/صمامات.
2	إنارة الطوارئ / إنارة المخارج	2	أنظمة الإطفاء التلقائية

ملاحظة: 1. يجب ابلاغ الإدارة العامة للدفاع المدني - دبي في حالة تغيير أو تعديل في البيانات المتعلقة في الترخيص الصادر من قبل الإدارة.
2. يجب على الشركة المعتمدة لدى إدارة الدفاع المدني - دبي إبراز الترخيص الساري المفعول الخاص بالمعدات المعتمدة والصادر من قبل الإدارة للمتعامل، وعلى الشركة تحمل المسؤولية عند انتهاء الترخيص أو إغلاق الشركة.
3. في حال إلغاء إقامة عمل المهندس أو الفني لدى الشركة المعتمدة أثناء سريان تاريخ الترخيص الصادر من قبل الإدارة العامة للدفاع المدني - دبي يجب ابلاغ الإدارة رسمياً وتقديم بطاقة المهندس أو الفني الأصل - يجب تقديم نسخة من إلغاء الإقامة.

Note: 1. Any changes to the product / manufacturer / location or specification the Dubai Civil Defense - GHQ must be notified
2. Manufacturers shall produce a valid approval of products whenever requested.
3. If employment visa of engineer / technician is cancelled before company's license expires, Dubai Civil Defense - GHQ must be notified, also a copy of visa cancellation must be submitted to Dubai Civil Defense - GHQ.

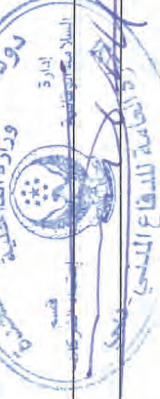

يعتمد / عن مدير الإدارة العامة للدفاع المدني - دبي
Signature of Directorate of Civil Defense - Dubai



رقم الترخيص : 2018-1-211032
سنة الترخيص : 2020
عدد التراخيص : 1

ترخيص صيانة و تركيب

تم إصدار الترخيص استنادا إلى القرار الوزاري رقم (24) لسنة 2012 ، في شأن تنظيم خدمات الدفاع المدني

الاسم التجاري للمنشأة : ماف الحريق الأمن والسلامة ش.ذ.م.م - فرع ابوظبي 1
اسم صاحب الترخيص : ماجد عبيد جمعه بن ماجد الفلاسي
رقم التسجيل : 2018-1-211032
رقم الرخصة : CN-2529525
الجنسية : الإمارات العربية المتحدة

نوع النشاط	رقم الهاتف	عنوان الشركة	الموقع و البريد الإلكتروني	تاريخ تأسيس المنشأة	عدد المهندسين المعتمدين	تاريخ الإصدار	تاريخ الانتهاء	منطقة النشاط	أبوظبي
1 * نظام الكشف والإنذار من الحريق (C)	0559987303	3 BUILDING - المصفح . مصفح التجارية . أبوظبي أبوظبي		25/04/2018	4	27/01/2020	26/01/2021	منطقة النشاط	أبوظبي
2 * أنظمة مكافحة الحريق (C)									
3 نظام التهوية والتحكم بالدخان									
4 المواد والطلاءات المبطنّة والممانعة لإنتشار الحريق									
5 نظام الأبواب والنوافذ والقواطع المقاومة للحريق والدخان									
6 التكسيات الخارجية الممانعة لانتشار الحريق									
7 نظام الغاز المركزي									

يعتمد/

رؤيتنا أن تكون دولة الإمارات العربية المتحدة من أفضل دول العا





رقم الترخيص : 2020-3-235051

سنة الترخيص : 2020

عدد التراخيص : 1

ترخيص موزع

 مصنع وكيل

تم إصدار الترخيص استناداً إلى القرار الوزاري رقم (24) لسنة 2012 ، في شأن تنظيم خدمات الدفاع المدني

2020-3-235051	رقم السجل	771571	رقم الرخصة	فرع -	ماف الحريق الأمن والسلامة ش.ذ.م.م -	الشارقة
	الجنسية	الهند	الجنسية	جاسمين سليمان سليمان فايلات	جاسمين سليمان سليمان فايلات	
	منطقة النشاط	الشارقة	رقم الهاتف	موزع معدات الإطفاء	موزع معدات الإطفاء	
	ص.ب	49895	رقم الفاكس	0557873143	0557873143	
	التاريخ الانتهاء	20/09/2020	تاريخ الإصدار	28/01/2020	28/01/2020	
	التاريخ الانتها	10/09/2021	تاريخ الإصدار	28/01/2020	28/01/2020	
	الموقع و البريد الإلكتروني	PRO@MAFSAFETY.AE	عنوان الشركة	مكتب رقم 103 طابق رقم 1 ملك خليفه راشد عبدالله محبان الكتبي - خلف شارع الشيخ محمد بن زايد . مويلح التجارية. الشارقة الشارقة	مكتب رقم 103 طابق رقم 1 ملك خليفه راشد عبدالله محبان الكتبي - خلف شارع الشيخ محمد بن زايد . مويلح التجارية. الشارقة الشارقة	
	عدد المعدات و الأجهزة المراد ترخيصها	55	عدد المعدات و الأجهزة المراد ترخيصها	55	55	
	تم تسديد الرسوم بإيصال رقم	(200052626340).	تم تسديد الرسوم بإيصال رقم	(200052626340).	(200052626340).	

يعتمد /
ختم



رؤيتنا أن تكون دولة الإمارات العربية المتحدة من أفضل دول العالم في تحقيق الأمن والسلامة

QUALITY CERTIFICATES





CERTIFICATE

OF REGISTRATION

This is to certify that the management system of

Maf Fire Safety & Security L.L.C

P.O. Box: 49895, Warehouse No: 05, Near Tasjeel Center, Industrial Area 5, Al Qusais, Dubai, United Arab Emirates.

has been assessed and registered by Veritas Assurance International as conforming to the requirements of

ISO 9001:2015

Quality Management System

The Quality Management System is applicable to:

Fire Fighting & Safety Equipment Trading
Fire Fighting Safety Equipment Installation

Certificate No : 32118811

Certificate issue date : 12-11-2019 | Certificate expiry date : 11-11-2022

1st Surveillance due before : 11-11-2020 | 2nd Surveillance due before : 11-11-2021

This certificate is validated through annual surveillance audit



Authorised Signatory
Veritas Assurance International

Accredited by : UAF (United Accreditation Foundation)
Full Member of IAF (International Accreditation Forum)

Registered Accreditation Office:
3510, Colmar, Norfolk, VA 23509, United States of America (USA)



CB-MS-3414
Full Member of IAF

This certificate remains valid while the holder maintains the management system in accordance with the standard(s) above, which will be periodically audited by Veritas Assurance International.

This certificate remains the property of Veritas Assurance International and must be returned on request. In the issuance of this certificate, Veritas Assurance International assumes no liability to any party other than to the client, and then only in accordance with the agreed upon certification agreement. Validity of this certificate may be confirmed at www.veritasassurance.com, directly through QR code by using any device with correct information or email to admin@veritasassurance.com.



www.veritasassurance.com



This certificate is printed on FSC Paper



CERTIFICATE

OF REGISTRATION

This is to certify that the management system of

Maf Fire Safety & Security L.L.C

P.O. Box: 49895, Warehouse No: 05, Near Tasjeel Center, Industrial Area 5, Al Qusais, Dubai, United Arab Emirates.

has been assessed and registered by Veritas Assurance International as conforming to the requirements of

ISO 14001:2015

Environmental Management System

The Environmental Management System is applicable to:

- Fire Fighting & Safety Equipment Trading
- Fire Fighting Safety Equipment Installation

Certificate No : 32118812

Certificate issue date : 12-11-2019 | Certificate expiry date : 11-11-2022

1st Surveillance due before : 11-11-2020 | 2nd Surveillance due before : 11-11-2021

This certificate is validated through annual surveillance audit

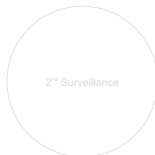

Authorised Signatory
Veritas Assurance International
Accredited by : UAF (United Accreditation Foundation)
Full Member of IAF (International Accreditation Forum)



CB-MS-3413
Full Member of IAF

Registered Accreditation Office:
3510, Colmar, Norfolk, VA 23509, United States of America (USA)

This certificate remains valid while the holder maintains the management system in accordance with the standard(s) above, which will be periodically audited by Veritas Assurance International.

This certificate remains the property of Veritas Assurance International and must be returned on request. In the issuance of this certificate, Veritas Assurance International assumes no liability to any party other than to the client, and then only in accordance with the agreed upon certification agreement. Validity of this certificate may be confirmed at www.veritasassurance.com, directly through QR code by using any device with correct information or email to admin@veritasassurance.com.



www.veritasassurance.com



This certificate is printed on FSC Paper



CERTIFICATE

OF REGISTRATION

This is to certify that the management system of

Maf Fire Safety & Security L.L.C

P.O. Box: 49895, Warehouse No: 05, Near Tasjeel Center, Industrial Area 5, Al Qusais, Dubai, United Arab Emirates.

has been assessed and registered by Veritas Assurance International as conforming to the requirements of

ISO 45001:2018

Occupational Health & Safety Management System

The Occupational Health & Safety Management System is applicable to:

Fire Fighting & Safety Equipment Trading
Fire Fighting Safety Equipment Installation

Certificate No : 32118813

Certificate issue date : 12-11-2019 | Certificate expiry date : 11-11-2022

1st Surveillance due before : 11-11-2020 | 2nd Surveillance due before : 11-11-2021

This certificate is validated through annual surveillance audit

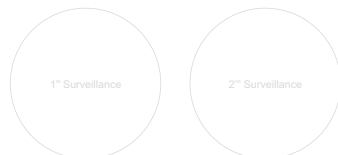

Authorized Signatory
Veritas Assurance International

Accredited by : UAF (United Accreditation Foundation)
Full Member of IAF (International Accreditation Forum)



CB-MS-4014
Full Member of IAF

Registered Accreditation Office:
3510, Colmar, Norfolk, VA 23509, United States of America (USA)

This certificate remains valid while the holder maintains the management system in accordance with the standard(s) above, which will be periodically audited by Veritas Assurance International.

This certificate remains the property of Veritas Assurance International and must be returned on request. In the issuance of this certificate, Veritas Assurance International assumes no liability to any party other than to the client, and then only in accordance with the agreed upon certification agreement. Validity of this certificate may be confirmed at www.veritasassurance.com, directly through QR code by using any device with correct information or email to admin@veritasassurance.com.



www.veritasassurance.com



This certificate is printed on FSC Paper

VERITAS ASSURANCE INTERNATIONAL

PRODUCTS CERTIFICATES



Kitemark™ Certificate

This is to certify that:

MAF Fire & Safety Equipment
General Trading
Al Qusais Industrial 1
Warehouse 1
PO Box 49895
Dubai
United Arab Emirates

Holds Certificate Number:

KM 696714

In respect of:

BS EN 3
Portable fire extinguishers

This issues the right and licence to use the Kitemark in accordance with the Kitemark Terms and Conditions governing the use of the Kitemark, as may be updated from time to time by BSI Assurance UK Ltd (the "Conditions"). All defined terms in this Certificate shall have the same meaning as in the Conditions.

The use of the Kitemark is authorized in respect of the Product(s) detailed on this Certificate provided at or from the above address.

For and on behalf of BSI:

Chris Lewis - Certification Director, Product Certification

First Issued: 2018-08-07

Latest Issue: 2018-08-07

Effective Date: 2018-08-07

Expiry Date: 2021-08-06

Page: 1 of 6



003

...making excellence a habit.™

Kitemark™ Certificate

This is to certify that:

MAF Fire & Safety Equipment
General Trading
Al Qusais Industrial 1
Warehouse 1
PO Box 49895
Dubai
United Arab Emirates

Holds Certificate Number:

KM 696715

In respect of:

BS EN 1866
Mobile Fire Extinguishers

This issues the right and licence to use the Kitemark in accordance with the Kitemark Terms and Conditions governing the use of the Kitemark, as may be updated from time to time by BSI Assurance UK Ltd (the "Conditions"). All defined terms in this Certificate shall have the same meaning as in the Conditions.

The use of the Kitemark is authorized in respect of the Product(s) detailed on this Certificate provided at or from the above address.

For and on behalf of BSI:

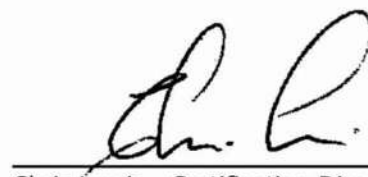

Chris Lewis - Certification Director, Product Certification

First Issued: 2018-08-07

Latest Issue: 2018-08-07

Effective Date: 2018-08-07

Expiry Date: 2021-08-06



Page: 1 of 2

...making excellence a habit.™

ZERTIFIKAT

Konformitätsbescheinigung



Registrier Nr.: AK 60128583 0001

Bericht Nr.: 21290093 001

Inhaber: **MAF fire & safety equipment**
General Trading
P.O. Box 49895, Al Qusais
Dubai
United Arab Emirates

Produkt: Notbeleuchtungsgerät
,Not- und Rettungszeichenleuchten

Identifikation: Bezeichnung: MOGX(W,D,S)(009)(blank, ML,ML-ELS)
MOKBU0(0-2)(1-8)(blank,SC);MOKBU0(0-2)(9)(blank,ML,ML-ELS)
MOKDU01(1-8)(blank,SC); MOKDU019(blank,ML,ML-ELS)
MOKMU01(1-8)(blank,SC,WL); MOKMU01(9)(blank,ML,ML-ELS)
MOKSU01(1-8)(blank,SC,WL); MOKSU019(blank, ML-ELS)
Technische Daten: AC 220-230 V; 50/60 Hz; DC 216 V;
2,7 W-7,1 W LED; Ta40; class II; IP20; IP40;
IP43; IP54; IP64; IP65; Anschlussklemmen
Wareneingangsnummer: A000136586 001-060

Grundlage: EN 60598-1:2015
EN 60598-2-22:2014

Die Konformitätsbescheinigung bezieht sich auf das o.g. Produkt. Es wird bescheinigt, dass das Prüfmuster der aufgeführten Beurteilungsgrundlage entspricht. Das Zertifikat stellt kein allgemein gültiges Urteil über die Serienfertigung des Produktes dar und berechtigt nicht zur Nutzung eines TÜV Rheinland Prüfzeichens.

Datum 10.04.2018

Zertifizierungsstelle
A circular blue stamp with the TÜV Rheinland logo in the center and the text 'TÜV Rheinland LGA Products GmbH' around the perimeter.
Dipl.-Ing. (FH) M. Lüttmann

TÜV Rheinland LGA Products GmbH - Tillystraße 2 - 90431 Nürnberg

Certificate of Product Approval

Certificate Number: 1383a-(cl-1)

Issue: 01

MAF FIRE AND SAFETY EQUIPMENT GENERAL TRADING

No. 83
Pingxin North Road
Pinghu
Shenzhen
China

is authorised to use the LPCB mark in association with the product(s) listed in this certificate and appendix having complied with the requirements of the standard(s) detailed below:

Product(s)

Cable Types as listed below:
LLT-FR Multi-Core Cables

Standard(s) (see Appendix for details)

BS 7629-1:2008
BS 6387:2013 (Category CWZ)
EN 50200:2006 (Class PH30)
EN 50200:2006 Annex E (30 mins)
BS 5839-1:2013 (Clause 26.2d Standard)

This Certificate is maintained and held in force through regular surveillance activities and subject to the corresponding ISO 9001 Certificate being maintained.

Signed for BRE Global Ltd.

Karen Coull
Certification Scheme Manager

2 August 2018
Date of Issue

2 August 2018
Date of First Issue



This certificate and appendix remain the property of BRE Global Ltd. and is issued subject to terms and conditions (for details visit www.redbooklive.com/terms).

To check the validity of this certificate and appendix please visit www.redbooklive.com/check, scan the QR tag or contact us.

BRE Global Ltd, Garston, Watford, WD25 9XX
T: +44 (0)333 321 8811 E: enquiries@breglobal.com

LPCB® is a registered trademark of the Building Research Establishment Ltd.



Kitemark™ Certificate

This is to certify that:

MAF Fire & Safety Equipment
General Trading
Al Qusais Industrial 1
Warehouse 1
PO Box 49895
Dubai
United Arab Emirates

Holds Certificate Number:

KM 698597

In respect of:

BS EN 54-5
Point Type Heat Detectors

This issues the right and licence to use the Kitemark in accordance with the Kitemark Terms and Conditions governing the use of the Kitemark, as may be updated from time to time by BSI Assurance UK Ltd (the "Conditions"). All defined terms in this Certificate shall have the same meaning as in the Conditions.

The use of the Kitemark is authorized in respect of the Product(s) detailed on this Certificate provided at or from the above address.

For and on behalf of BSI:

Chris Lewis - Certification Director, Product Certification

First Issued: 2018-10-19

Latest Issue: 2018-10-19

Effective Date: 2018-10-19

Expiry Date: 2021-10-18



Page: 1 of 2

...making excellence a habit.™

Kitemark™ Certificate

This is to certify that:

MAF Fire & Safety Equipment
General Trading
Al Qusais Industrial 1
Warehouse 1
PO Box 49895
Dubai
United Arab Emirates

Holds Certificate Number:

KM 698598

In respect of:

BS EN 54-7
Point Type Smoke Detectors

This issues the right and licence to use the Kitemark in accordance with the Kitemark Terms and Conditions governing the use of the Kitemark, as may be updated from time to time by BSI Assurance UK Ltd (the "Conditions"). All defined terms in this Certificate shall have the same meaning as in the Conditions.

The use of the Kitemark is authorized in respect of the Product(s) detailed on this Certificate provided at or from the above address.

For and on behalf of BSI:

Chris Lewis - Certification Director, Product Certification

First Issued: 2018-10-19

Latest Issue: 2018-01-19

Effective Date: 2018-01-19

Expiry Date: 2021-01-18



Page: 1 of 2

...making excellence a habit.™

INSURANCE





Workmen's Compensation Insurance Certificate

To Whomsoever It May Concern

Date: 29/01/2020

We confirm having effected Workmen's Compensation Insurance for **M/s MAF FIRE SAFETY & SECURITY LLC** as per the following details:

Policy No.	: 0102060201468320000000
Insured	: M/s MAF FIRE SAFETY & SECURITY LLC
Additional Insured	: MAF GAS LLC for their respective rights and interests
Period of Insurance	: From 29/01/2020 to 28/01/2021 (Both Dates Inclusive)
Scope of Cover	: As per Standard Workmen's Compensation Insurance Policy issued in accordance with UAE Federal Law No.8 of the year 1980 and subsequent amendments thereto &/or Common Law &/or Shariah Law
Number of Employees	: 53
Employer's Liability Limit	: AED 1 Million any one occurrence and in the aggregate
Territory	: United Arab Emirates
Jurisdiction	: United Arab Emirates

This certificate is issued at the request of the Insured and the cover is subject to terms, conditions and limitations of the said policy.

For Oman Insurance Company (PSC)



Authorized Signatory

VEHICLES DETAILS

S No	No	SEATER	CAR NAME
1	1	5	RANGE ROVER SPORT
2	2	7	LAND CRUSER TOYOTA
3	4	7	TOYOTA FORTUNER
4	11	5	TOYOTA COROLLA
6	8	5	TOYOTA CAMRY
7	3	7	TOYOTA AVANZA
8	2	15	TOYOTA HIACE(Van)
9	9	5	TOYOTA YARIS
10	2	13	TOYOTA COASTER
11	2	2	BAJAJ PULASR 180C
12	1	2	BAJAJ PULASR 220CC
13	1	3	TOYOTA HINO PICK UP
14	2	13	TOYOTA HIACE MINI BUS



CSR ACTIVITIES

The initiatives put forward by MAF in Corporate Social Responsibility aims at imparting complete benefits to the society. It includes expanding organizational ethical codes, effective participation of employees and launching new programs and initiatives by holding company culture. CSR mainly presents its impression through charitable, philanthropic, environmental and volunteer based categories. It can also be the ultimate development process that includes effective participation of both public and private sectors.

CSR has become a quite important facet of a private company's hierarchy that must be integrated to its mission and vision.



OUR TEAM

Our team members are our greatest asset.

Our ability to deliver outstanding results for our clients starts with our team of smart, capable PR experts. The team comes from a diverse set of experiences and backgrounds that range from various sectors. As unique as we are individually, we share a mutual passion for technology and doing excellent work for our clients and partners. We pride ourselves on our strategic, integrated approach to public relations and the results it delivers.

Get to know your MAF team below.







A CLIENTELE SO CONTENTED

At MAF, we are certain that the core goal of our business is the smile of a happy customer. Needless to say, our efforts to keep our clients smiling have won us continued patronage from them. We have been proud to associate with some of these big names who have set benchmarks in their own industry segments. We have already accomplished a few milestones in our trail to growth. Have a look at some of our completed projects that speak loud on the quality of our products and services:



BURJUMAN MALL



PARK HYATT



UP TOWER



SHERATON
SHEIKH ZAYED ROAD



SHERATON - CREEK



RADISSON BLU HOTEL



CAPITAL BAY



AL-GHAZAL MALL



S No.	CLIENT NAME	SITE NAME	LOCATION
1	CONMIX	STAFF ACCOMMODATION	DIP
2	INDEPENDENT TOBACCO	WAREHOUSE	JAFZA
3	JBC EXPRESS FREIGHT LLC	WAREHOUSE +OFFICE	JAFZA
4	RIVOLI GROUP	SILICON STAR 2 BUILDING	DSO
5	NATIONAL STORE	CANON SHOP	MIRDIFF City Centre
6	AL ABBAR REAL ESTATE	PARK RESIDENCE, LABOUR CAMP	DIP
7	NATIONAL STORE	SHOP NO 528	GAZAL MALL
8	VOX CINEMA	VOX CINEMA	PORT SAEED
9	COLLIERS INTERNATIONAL	UP TOWER	SHEIKH ZAYED ROAD
10	HYATT	PARK HYATT HOTEL	CREEK
11	TOWHEED IRANIAN SCHOOL	TOWHEED IRANIAN SCHOOL	ALQUOZ
12	SACOOR BROS	MERCATO	JUMEIRAH
13	BLUE MANDARINE	RESTRAURANT	MUROOJ
14	PROTECHNOLOGY	PROTECHNOLOGY	AL QUOZ
15	AL ARIF CONTRACTING CO. LLC	LEGACY WAREHOUSE (SHED 12)	RAS AL KHOR
16	AL JAWI INVESTMENT	ICON TOWER COMMERCIAL BUILDING	TECOM
17	ABDUL QADER SHARFI	W/H 24	RASHIDIYA
18	GIORDANO	GIORDANO	DEIRA CITY CENTRE
19	DAMAC	CAPITAL BAY	BUSINESS BAY
20	EMIRATES HILLS	EMIRATES HILLS VILLA NO.35	EMIRATES HILLS
21	BURJUMAN MALL	BURJUMAN MALL	BURJUMAN
22	CONVERGENT	CONVERGENT	AL QUOZ

23	MOORFIELDS	MOORFIELDS EYE HOSPITAL	HEALTH CARE CITY
24	HYATT REGENCY-	HOTEL APARTMENT FIRE FIGHTING ONLY	HEALTH CARE CITY
25	ARJ PROPERTIES	OPP.BURJUMAN CENTRE	BURJUMAN
26	EMERGINE ABRASIVES	OFFICE & WARE HOUSE	DWC
27	AL MAHA	LUXURY COLLECTION	AL AIN ROAD DUBAI
28	AURIS INN AL MUHANNA HOTEL	AURIS INN AL MUHANNA HOTEL	TECOM
29	GALADARI REAL ESTATE	LABOUR CAMP	SONAPUR
30	SK HABTOOR	24W/H	RASHIDIYA
31	SHERATON	HOTEL APARTMENT	S Z ROAD
32	AL SHOWAIB REAL ESTATE	AL ARIF LABOUR CAMP 1	AL QUOZ IND
33	ACCURATE VISION	18 WAREHOUSE G+M	DIP 2
34	SBK REAL ESTATE	OASIS BUILDING	AL BARSHA
35	TRANSEMIRATES CONTR	LABOUR CAMP	SONAPUR
36	SUN INPEX INTERNATIONAL FOODS LLC	W/H 10'NOS	AL QUSAIS
37	MPM PROPERTIES	MOROCCO G5	INTERNATIONAL CITY
38	SEVERN GLOCON- FEZ	SEVERN GLOCON- FEZ	JAFZA
39	CONMIX	CONMIX CEMENT FACTORY	DIC
40	DIRP	OFFICE & FACTORY	RASHIDIYA
41	LONDON CROWN 2 - HOTEL	HOTEL APARTMENTS (B+G+7)	BURDUBAI
42	M M GROUP	LABOUR CAMP (A, B, C, D, E - BLOCK)	SONAPUR
43	LAYAN FOOD TRADING	(OFFICE + WAREHOUSE)	DIP 2
44	DONOR KABAB	DONAR KABAB	TECOM
45	TECHORBIT	OFFICE + WAREHOUSE	DIP

46	JACKSON TRADING	MAIN OFFICE	KHABAISI DEIRA
47	GULF TARGET HOLDINGS	VILLA 5 -DESERT	AL BARARI
48	BAB AL FIRDOUS FOOD STUFF	BAB AL FIRDOUS FOOD STUFF	DIC
49	AL SHOWAIB	BLDG 107	DEIRA NAKHEEL
50	HAMDAN JUMA BUILDING	TECH STUDIO BLDG	KARAMA
51	AL MANA RETAIL LLC	JOHN LOBB SHOP (G/68)	DUBAI MALL
52	ELAPCO	ELAPCO WAREHOUSE	JABAL ALI
53	MADINA MALL	MADINA MALL LABOUR CAMP	AL WARSAN
54	LULU GROUP	LULU WARE HOUSE	JAFZA
55	GRAND MIDWEST	GRAND MIDWEST HOTEL APARTMENT	DISCOVERY GARDEN
56	ABM-BILT	ABM-BILT LABOUR CAMP-2(G+1) 3 BLOCKS	AL QUOZ
57	MAZ CONSULTANTS	COPORATE OFFICE	AL QUOZ
58	ASTECO	PROPERTY MANAGEMENT G+15	SHARJAH
59	ATOS LOMBARDINI	ATOS LOMBARDINI	CITY WALK
60	LMM GENARAL TRADING	LMM GENARAL TRADING	PORTS SAEED
61	CAPITOL REAL STATE LLC	PRODUCT HOUSE WAREHOUSE WAQ 36	AL QUOZ
62	AL GHURAIR PRINTING	FALCON PAPER INDUSTRY-STL CAPITOL	AL QUOZ
63	CREATIVE LINE DÉCOR	CALIFORNIA PIZZA KITCHEN	DUBAI
64	KAMAT RESTAURANT	KAMAT RESTAURANT @SHARAFI MANKHOOL BUILDING	BUR DUBAI
65	KANGAROO KIDS	KIDS NURSERY	AL SAFA
66	DAMAC	VOGUE @BUSINESS BAY	BUSINESS BAY
67	RIG CROSSFIT	W/H # 19 & 37	AL QUOZ
68	RADISSON BLU	EAST TOWER	MEDIA CITY



69	ABDUL QADER SHARAFI	COMPLEX CONSISTING AND FIXED ACCE	BUR DUBAI
70	GAZEBO RESTAURANT	MONA ALI MOHAMED BUILDING	MANKHOOL
71	WOODSTRUCT CARPENTARY LLC	W/H 5	DUBAI
72	GOLDEN SPECTRUM	COMMERCIAL BUILDING PLOT NUMBER	UMM SUQUEIM
73	SBK REAL ESTATE	REDHA BUILDING	AL KARAMA
74	ABDUL QADER SHARAFI	40 WAREHOUSES	RAS AL KHOR
75	BOOK WORM	WAQ WAREHOUSE 34	AL QUOZ
76	KEVIN CATERING	WAREHOUSE - 4	DIC
77	CRC INTERNATIONAL	WAREHOUSE	ALQUOZ IND.3
78	BRANDS FOR LEES	GHAZAL MALL	SATWA
79	AJ HOSPITAL	STAFF ACC AJMAN	AJMAN
80	ACCURO SPECIALIST SERVICES	OFFICE + WAREHOUSE	DIP
81	RADISSON BLU	WEST TOWER	MEDIA CITY
82	START CONSULT	MY SHAWARMA	AL BARSHA
83	NATIONAL ALUMINIUM EXTRUSION	OFFICE + WAREHOUSE	DIP2
84	CHELSEA PLAZA	HOTEL APARTMENTS	SATWA
85	CAPITOL REAL ESTATE LLC	HISTORICAL BUILDING	AL DHAGAYA
86	AL GHADEER REAL ESTATE	BLDG 2 (G+M+4) & (G+M+5)	DUBAI
87	AL BASTI & MUKTHA	LABOUR CAMP	ALQUOZ
88	VICTORY HEIGHTS PRIMARY SCHOOL	B+G+1	SPORTS CITY
89	HOME AND HOME	REAL ESTATE BROJKER	DIP
90	MARHABA MALL	MARHABA MALL	RAS AL KHOR



ABUDHABI DUBAI SHARJAH



MAF FIRE SAFETY & SECURITY LLC

Al Qusais Industrial -5 , Dubai, UAE.

Tel: +971 4 239 7910 Fax : +971 4 239 8710

TOLL FREE: 800 FIRE (800 3473)

info@mafsafety.ae

www.mafsafety.ae

[facebook/mafsafety](https://www.facebook.com/mafsafety) [Instagram](https://www.instagram.com/mafsafety) [YouTube](https://www.youtube.com/mafsafety)

dunes capital

www.dunescapital.ae
[facebook.com/dunescapital](https://www.facebook.com/dunescapital)